

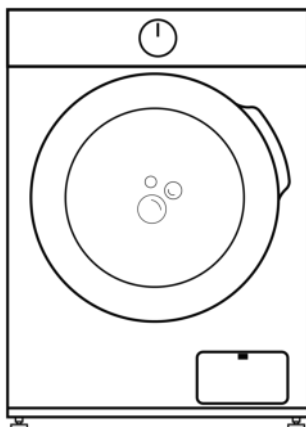

**LAVADORA**

WASHING MACHINE  
LAVE-LINGE  
MÁQUINA DE LAVAR



**SERIE ADRA**

**MANUAL  
DE INSTRUCCIONES**  
INSTRUCTION MANUAL  
GUIDE D'UTILISATION  
MANUAL DE INSTRUÇÕES



Escanee para ver este manual en otros idiomas y actualizaciones  
Scan for manual in other languages and further updates  
Manual dans d'autres langues et mis à jour  
Manual em outras línguas e atualizações

# ÍNDICE

ES

## **3 INSTRUCCIONES DE SEGURIDAD**

3 Instrucciones de seguridad

---

## **7 ESPECIFICACIONES**

## **8 DESCRIPCIÓN DEL PRODUCTO**

## **9 INICIO RÁPIDO**

## **12 INSTALACIÓN**

## **16 FUNCIONAMIENTO**

## **31 LIMPIEZA Y CUIDADO**

---

## **35 RESOLUCIÓN DE PROBLEMAS**

## **36 DISPOSICIÓN DE ELIMINACIÓN**

## **38 GARANTÍA**

# INSTRUCCIONES DE SEGURIDAD

## Uso previsto

El producto está destinado únicamente para uso doméstico y para textiles en cantidades domésticas aptas para el lavado. Este aparato es sólo para uso en interiores y no está diseñado para uso integrado. Utilícelo únicamente de acuerdo con estas instrucciones.

El aparato no está destinado a un uso comercial.

Cualquier otro uso se considera inadecuado. El fabricante no se hace responsable de los daños o lesiones que puedan derivarse del mismo.

Este aparato está destinado a ser utilizado en aplicaciones domésticas y similares, tales como:

- Zonas de cocina para el personal en tiendas, oficinas y otros entornos de trabajo.
- Casas de campo.
- Para clientes de hoteles, moteles y otros entornos de tipo residencial.
- Ambientes tipo bed&breakfast.
- Zonas de uso común en pisos o lavanderías de bloques de apartamentos.

## Explicación de símbolos



### PELIGRO

Este símbolo indica que existen peligros para la vida y la salud de las personas debido al gas extremadamente inflamable.



### ADVERTENCIA DE TENSIÓN ELÉCTRICA

Este símbolo indica que existe peligro para la vida y la salud de las personas debido a una alta tensión.



### ADVERTENCIA

Este símbolo indica una situación potencialmente peligrosa que, de no evitarse, puede provocar la muerte o lesiones graves.



### ATENCIÓN

Este símbolo indica una situación potencialmente peligrosa que puede resultar en lesiones moderadas o leves.



### NOTA

Este símbolo indica información importante (p.ej. daño a la propiedad), pero no peligro.



### OBSERVE LAS INSTRUCCIONES

Este símbolo indica que sólo el servicio técnico debe utilizar y mantener este aparato de acuerdo con las instrucciones de funcionamiento.

Por su seguridad, debe seguir la información de este manual para minimizar el riesgo de incendio o explosión, descarga eléctrica y para evitar daños a la propiedad, lesiones personales o la muerte. No seguir estas indicaciones invalidará su garantía.

Este aparato no está destinado a ser utilizado por personas (incluidos niños) con capacidades físicas, sensoriales o mentales reducidas, o con falta de experiencia y conocimientos, a menos que hayan sido supervisadas o instruidas acerca del uso del aparato por una persona responsable de su seguridad.

## ADVERTENCIA: Descarga eléctrica

- Si el cable de alimentación está dañado, debe sustituirlo el fabricante, el servicio técnico oficial u otras personas igualmente cualificadas.
- Si la máquina está dañada, no debe utilizarse a menos que haya sido arreglada por el fabricante, su servicio técnico u otras personas igualmente cualificadas.
- Riesgo de descarga eléctrica.
- El aparato puede ser utilizado por niños a partir de 8 años y personas con capacidades físicas, sensoriales o mentales reducidas o con falta de experiencia y conocimiento si han recibido supervisión o instrucciones sobre el uso del aparato de forma segura y comprenden los peligros que implica. Los niños no deben jugar con el aparato, y no deben realizar la limpieza y el mantenimiento del usuario sin supervisión.
- Mantenga a los niños supervisados para que no jueguen con el aparato.
- Los niños menores de 3 años deben ser supervisados continuamente para asegurarse de que no jueguen con el aparato.
- Compruebe la lavadora antes de cada uso, los niños y animales pueden subirse a ella.
- No se suba ni se siente sobre el aparato.

## Ubicación y entorno de la instalación

- Guarde todos los detergentes y los productos de lavado en un lugar seguro, fuera del alcance de los niños.
- No instale el aparato sobre moquetas o alfombras.
- Si las aberturas quedan obstruidas la lavadora podría averiarse.
- Mantenga el aparato alejado de fuentes de calor y de la luz directa del sol para evitar la corrosión de las partes de plástico y la goma.
- No utilice el aparato en ambientes o estancias húmedas o que contengan gas explosivo o cáustico. En caso de que haya una fuga de agua o sapolcaduras que afecten al aparato, deje que se seque al aire libre.
- No instale la lavadora detrás de puertas con cerradura, correderas o puertas que tengan bisagras en el lado contrario al de la lavadora.
- No utilice el aparato en habitaciones con una temperatura inferior a 5°C, ya que esto puede causar daños alguno de sus componentes. Si es inevitable, asegúrese de drenar el aparato por completo tras cada uso (consulte "Mantenimiento - Limpieza del filtro de la bomba de desagüe") para evitar daños causados por el hielo.
- Nunca use sprays o sustancias inflamables cerca del aparato.

## Instalación

- Retire todo el embalaje y los tornillos de transporte antes de utilizar el aparato o podrían producirse daños graves.
- Este aparato está equipado con una válvula de entrada única y solo puede conectarse al suministro de agua fría.
- La toma de corriente debe ser accesible después de la instalación.
- Antes de lavar prendas por primera vez, ponga en marcha el aparato en un ciclo sin ropa dentro para limpiarlo.
- Antes de usar la lavadora, debe calibrarse.
- No coloque objetos muy pesados ni calefactores sobre el aparato.

# INSTRUCCIONES DE SEGURIDAD

- Utilice los tubos nuevos que se suministras con el aparato, no reutilice tubos viejos.
- Presión máxima del agua de entrada: 1 MPa. Presión mínima del agua de entrada: 0.05 MPa.

## Conexión eléctrica

- Asegúrese de que el cable de alimentación no queda atrapado por la lavadora, ya que podría dañarse.
- Conecte el aparato a una toma de corriente con conexión a tierra protegida por un fusible que cumpla con los valores de la tabla "Especificaciones técnicas". La instalación de la toma de tierra debe ser realizada por un electricista cualificado. Asegúrese de que la lavadora esté instalada de acuerdo con la normativa local.
- Las conexiones de agua y electricidad deben ser realizadas por un técnico cualificado de acuerdo con las instrucciones del fabricante y las normas de seguridad locales.



## ADVERTENCIA

- No use regletas, enchufes múltiples ni alargaderas.
- El aparato no debe alimentarse mediante un interruptor externo, como un temporizador, ni conectarse a un circuito que se encienda y apague habitualmente.
- No desconecte el enchufe de la toma de corriente si hay gas inflamable cerca.
- Nunca desenchufe el aparato con las manos mojadas.
- No tire con fuerza del cable de alimentación, sujételo por el enchufe.
- Desconecte el aparato si no está en uso.

## Instalación de agua

- Compruebe las conexiones de las tubería de entrada de agua, la llave de agua y la tubería de desagüe para detectar posibles problemas debidos a cambios de presión del agua. Si las conexiones se aflojan o gotean, cierre la llave de paso y repárela.
- No use el aparato antes de comprobar que las tuberías y conexiones están debidamente instaladas por personal cualificado.
- La puerta de cristal puede calentarse mucho durante el funcionamiento. Mantenga a los niños y animales alejados del aparato mientras esté en funcionamiento.
- Las tuberías de entrada y salida de agua deben instalarse con seguridad y no deben deteriorarse o puede dar lugar a fugas de agua.
- No retire el filtro de la bomba de desagüe mientras quede agua en el aparato. Pueden verterse grandes cantidades de agua que podrían provocarle quemaduras.

## Funcionamiento y mantenimiento

- No utilice nunca disolventes inflamables, explosivos o tóxicos. No debe utilizarse a modo de detergentes sustancias como gasolina, alcohol, etc. Utilice sólo detergentes adecuados para el lavado a máquina.
- Asegúrese de vaciar todos los bolsillos. Los objetos afilados y rígidos como monedas, broches, clavos, tornillos, piedras, etc. pueden causar graves daños a este aparato.
- Retire todos los objetos de los bolsillos, como mecheros y cerillas. Enjuague concienzudamente las prendas lavadas a mano.

- Las prendas que se hayan manchado de sustancias como aceite de cocina, acetona, alcohol, gasolina, queroseno, quitamanchas, aguarrás, cera o quitaceras deben lavarse en agua caliente con una cantidad extra de detergente antes de secarse.
- Los artículos como la gomaespuma (espuma de látex), los gorros de ducha, los tejidos impermeables, los artículos con respaldo de goma y la ropa o las almohadas con almohadillas de gomaespuma no deben secarse en el aparato.
- Los suavizantes o productos similares, deben utilizarse según las instrucciones.
- La puerta se desbloqueará poco después de finalizar un ciclo. No intente abrirla a la fuerza.
- No cierre la puerta con demasiada fuerza. Si le resulta difícil cerrar la puerta, compruebe si la ropa está bien introducida y distribuida.
- Desenchufe el aparato y cierre la llave de paso antes de la limpieza y el mantenimiento, así como después de cada uso.
- No vierta nunca agua sobre el aparato para limpiarlo, puede provocar una descarga eléctrica.
- Las reparaciones solo deben ser realizadas por el fabricante, su servicio técnico o profesionales cualificados para evitar riesgos. El fabricante no se hará responsable de los daños causados por la intervención de personas no autorizadas.

## Transporte

- Antes del transporte:
  - Un profesional cualificado debe volver a instalar los tornillos de transporte.
  - El agua acumulada debe drenarse del aparato.
- Este aparato pesa mucho, transpórtelo con cuidado. No sujete nunca ninguna parte saliente de la lavasecadora al levantarla. No utilice la puerta del aparato como asa de transporte.

Modelo	Capacidad de lavado
ADRA100	10.0kg
ADRA120	12.0kg

# ESPECIFICACIONES

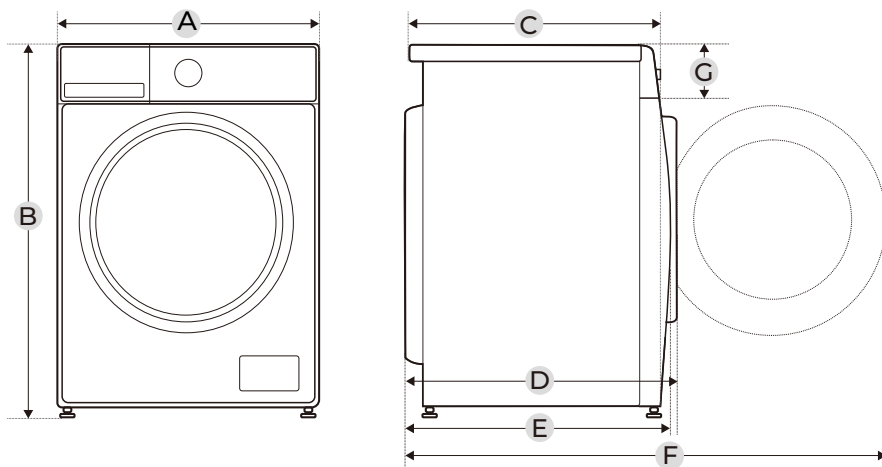

Modelo	ADRA100	ADRA120
Alimentación	220-240V~,50Hz	
Corriente máxima	10A	
Presión de agua estándar	0.05MPa~1MPa	
Capacidad lavado	10.0kg	12.0kg
<b>Dimensiones</b>		
A	595mm	595mm
B	850mm	850mm
C	530mm	595mm
Peso	65kg	73kg
Potencia nominal	2000W	2000W
<b>Dimensiones de referencia</b>		
D	600mm	660mm
E	540mm	641mm
F	1045mm	1105mm
G	135mm	135mm

# DESCRIPCIÓN DEL PRODUCTO

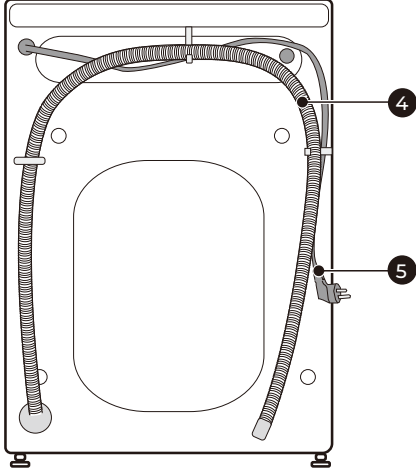
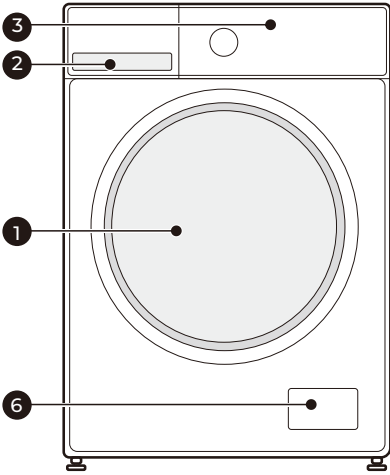

1	Puerta	4	Manguera de desagüe
2	Dispensador de detergente	5	Cable de alimentación
3	Panel de control	6	Filtro de servicio

**● NOTA**

La ilustración sólo sirve como referencia, refiérase siempre al producto real como estándar.

## Accesorios

- 4 x Tapas
- 1 x Tubo de suministro de agua fría
- 1 x Manual de instrucciones
- Espumas acústicas (opcional según modelo)

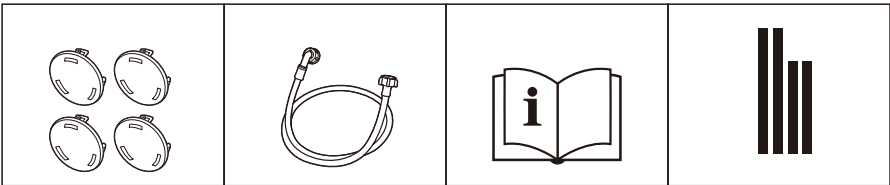



# INICIO RÁPIDO

## ALERTA

- Asegúrese de que la lavadora está bien instalada antes de usarla.
- El producto pasa una revisión exhaustiva antes de salir de fábrica. Para eliminar cualquier agua residual y neutralizar olores se recomienda limpiar el aparato antes del primer uso, poniendo en marcha "Limp. tambor" o cualquier otro programa con la opción de temperatura a 90°C sin prendas ni detergente.

## Calibración

Es recomendable calibrar para obtener los mejores resultados.

El aparato puede detectar la cantidad de carga que se introduce. Esta función optimiza el rendimiento del producto y minimiza el consumo de energía y agua, y por tanto, ahorra tiempo y dinero al usuario. Por este motivo le sugerimos calibrarla siguiendo los pasos indicados a continuación:

- 1- Retire todos los accesorios del tambor y cierre la puerta.
- 2- Conecte el cable de alimentación a la toma de corriente.
3. Encienda la lavadora y pulse "Centrifug." durante 3 segundos aproximadamente hasta que se muestre "t19".
- 4- Pulse  para iniciar el aparato, al principio se mostrará "---" y, a continuación, "\*\*\*\*" (como por ejemplo "126") para indicar la velocidad del tambor en tiempo real. Cuando el número alcanza un valor determinado (deja de cambiar), significa que la lavadora se ha calibrado correctamente

## 1. Antes del lavado

### 1. Enchufe

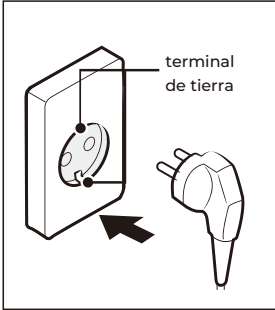

### 2. Abra la llave de paso

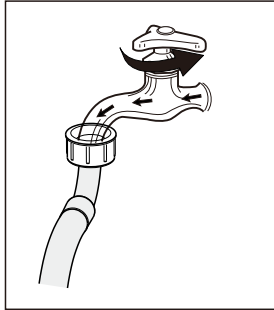

### 3. Cargue

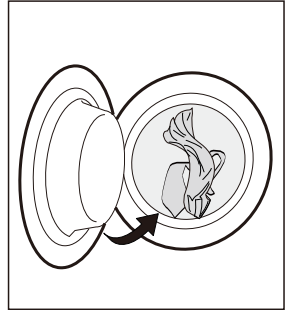

### 4. Cierre la puerta

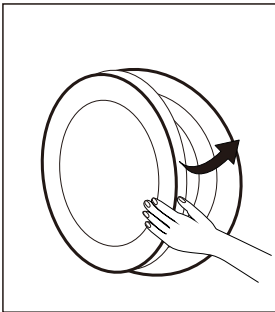

### 5. Añada detergente

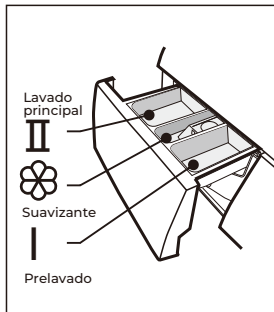

### ● NOTA

Debe añadir el detergente en el cajetín I si selecciona el prelavado.

## 2. Lavado

1. Elija programa

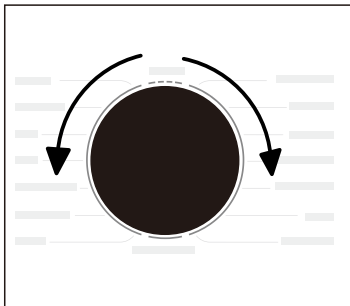

2. Seleccione función o mantenga la predeterminada

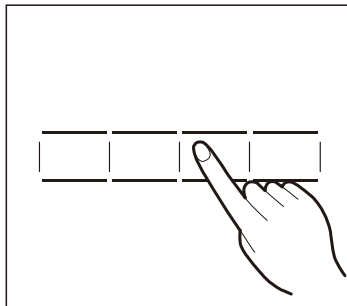

3. Pulse Inicio/Pausa para empezar el lavado

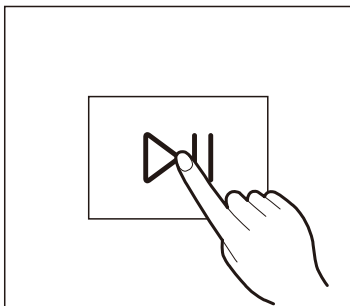

### ● NOTA

1: Si se selecciona la función predeterminada, puede omitirse el paso 2.  
2: El gráfico de la rueda de programas es sólo de referencia, refiérase al producto real como estándar.

## 3. Después del lavado

Sonará un timbre y en la pantalla aparecerá "End".

# INSTALACIÓN DEL PRODUCTO

 Herramientas necesarias si la instalación la realiza usted mismo (no incluidas)

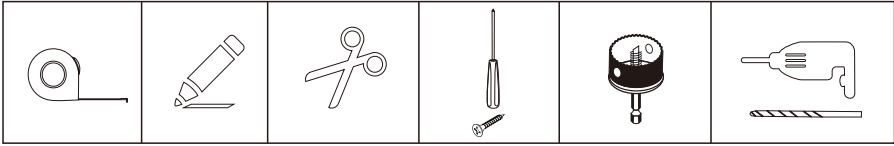

## Área de instalación

### ADVERTENCIA

- La estabilidad es importante para evitar que el producto se desplace. Asegúrese de que la lavadora está nivelada y estable.
- Asegúrese de que el aparato no se apoya sobre el cable de alimentación.
- Procure respetar las distancias mínimas de las paredes que se muestran en la imagen.

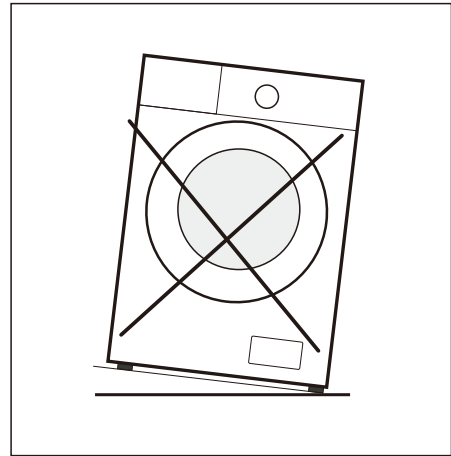
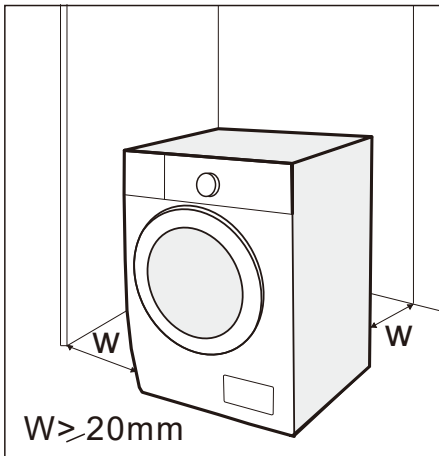

Antes de instalar el aparato, debe seleccionarse una ubicación que cumpla con las siguientes características:

1. Superficie sólida, seca y equilibrada
2. Sin impacto directo de la luz solar
3. Con suficiente ventilación
4. Temperatura ambiente superior a 5°C
5. Alejada de fuentes de calor como carbón o gas.

## Desembalaje de la lavadora

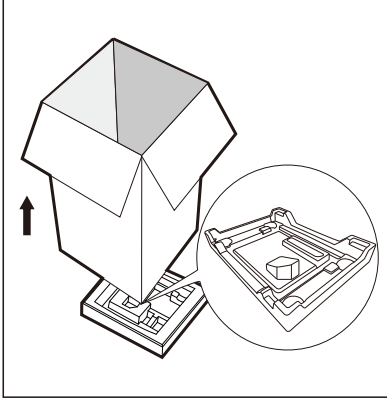

### ⚠ ADVERTENCIA

- El material de embalaje (p. ej. plásticos, espuma de poliestireno) puede ser peligroso para los niños.
- Existe riesgo de asfixia. Mantenga todos los envoltorios fuera del alcance de los niños.

1. Retire la caja de cartón y el embalaje de poliestireno.
2. Levante la lavadora y retire el embalaje de la base.
3. Retire la cinta adhesiva que sujeta el cable de alimentación y la manguera de drenaje.
4. Retire la manguera de entrada del tambor.

## Quitar los pernos de transporte

### ⚠ ADVERTENCIA

Retire los tornillos de transporte de la parte trasera antes de utilizar el producto.

1. Afloje los 4 tornillos de transporte con una llave.

2. Retire los tornillos y las arandelas de goma, y consérvelos para futuros usos.

3. Cierre los agujeros con las tapas.

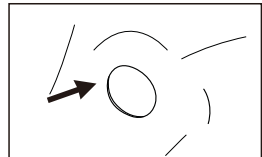
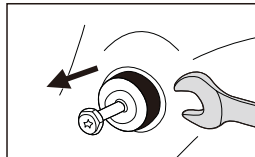
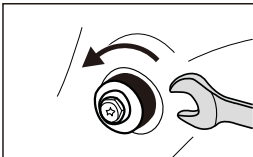

# INSTALACIÓN DEL PRODUCTO

## Nivelación de la lavadora

### ⚠ ADVERTENCIA

Debe apretar con firmeza las cuatro tuercas de las patas.

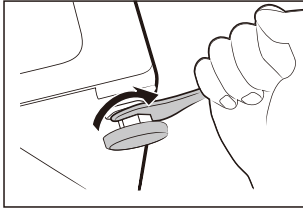

1. Afloje la tuerca de bloqueo.
2. Gire la pata hasta que llegue al suelo.
3. Ajuste las patas y apriete las tuercas con una llave. Asegúrese de que la lavadora esté nivelada y estable.

## Conectar la tubería de entrada de agua

### ⚠ ADVERTENCIA

Para evitar fugas o daños por agua, debe seguir estas instrucciones.

- No tuerza, aplaste ni modifique la tubería de entrada de agua.

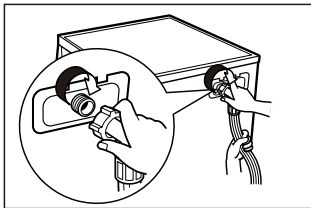

Conecte la manguera de suministro a la válvula de entrada de agua y a un grifo con agua fría como se indica.

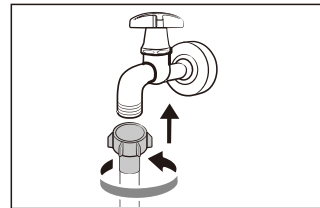

### ● NOTE

- Realice la conexión manualmente, no utilice herramientas. Compruebe si las conexiones están bien apretadas.

## Tubería de desagüe

### ⚠ ADVERTENCIA

- No doble ni prolongue la tubería de desagüe.
- Colóquela correctamente o puede haber fugas de agua.
- No está permitido quitar la hebilla de la tubería de desagüe.

Hay dos formas de conectar el extremo de la tubería de desagüe:

1. Al desagüe principal

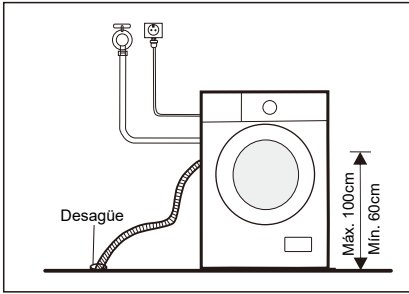

2. Conectarlo a un ramal del desagüe principal.

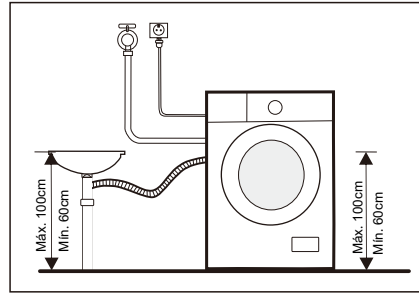

## Esponja acústica

**NOTA**

- Asegúrese de instalar las esponjas acústicas, que pueden ayudar a reducir el ruido causado por la máquina durante el funcionamiento y garantizar un ambiente tranquilo en el hogar.

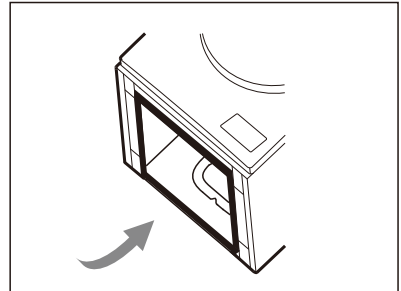
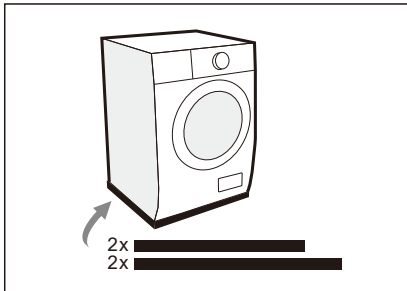

1. Tumbe el aparato sobre una superficie acolchada para protegerlo.
2. Pegue las 2 tiras de esponja más largas a los lados largos de la unidad, y las 2 tiras cortas a los lados más estrechos.

# FUNCIONAMIENTO

## Antes de cada lavado

- El rango de temperatura ambiente de funcionamiento de la lavadora debe estar entre 5-40°C. Si se usa por debajo de 0°C, la válvula de entrada y el sistema de drenaje pueden dañarse. Si el aparato se instala bajo condiciones muy bajas, debe cambiarse a una temperatura ambiente normal para asegurar que la tubería de suministro de agua y de desagüe se descongelen antes del uso.
- Compruebe las etiquetas y las instrucciones del detergente antes del uso. Utilice detergente sin espuma adecuado para el lavado a máquina.

1. Saque todo lo que haya en los bolsillos

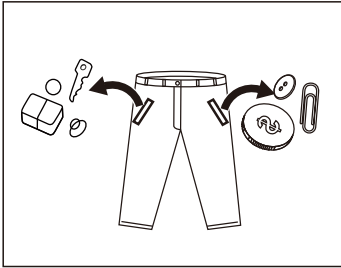

2. Separe las prendas según su color y textura

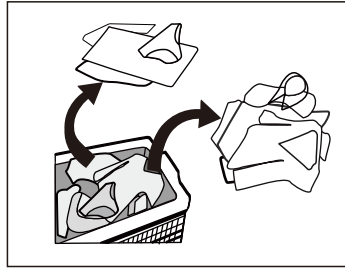

3. Anude las cintas, cremalleras y botones

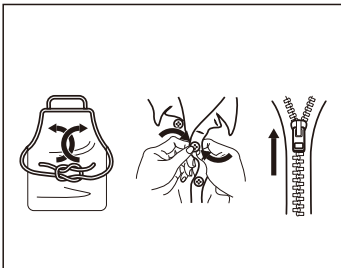

4. Ponga las prendas pequeñas en una funda

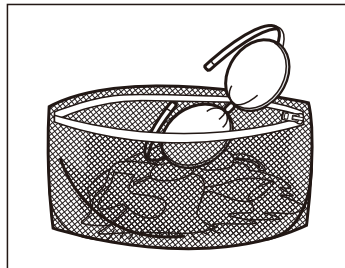



### ⚠ ADVERTENCIA

- No lave o seque productos que hayan estado en contacto con queroseno, gasolina, alcohol, cera, aceite, pintura y otras sustancias inflamables.
- Lavar una sola prenda puede desequilibrar la lavasecadora y hacer saltar alguna alerta. Es recomendable añadir una o dos prendas más para equilibrar el lavado y centrifugado.
- No lave, centrifuge o seque asientos, alfombrillas o ropa impermeables.







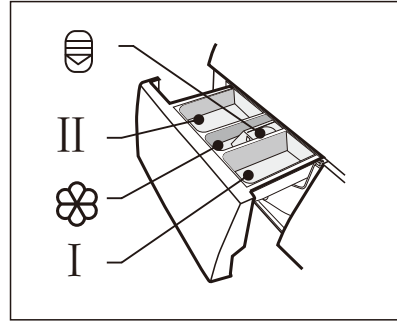









## Dispensador de detergente

- I Prelavado
- II Lavado principal
-  Suavizante
-  Botón para sacar el dispensador



### AVISO





- Solo debe añadir detergente al compartimento "I" después de seleccionar la función de prelavado.

Programa	I	II / 		Programa	I	II / 	
Algodón/Algodão 	<input type="radio"/>	<input checked="" type="radio"/>	<input type="radio"/>	Centrifugado 			
Sintéticos 	<input type="radio"/>	<input checked="" type="radio"/>	<input type="radio"/>	R. de cama 	<input type="radio"/>	<input checked="" type="radio"/>	<input type="radio"/>
Mix 	<input type="radio"/>	<input checked="" type="radio"/>	<input type="radio"/>	Lana/Lã 		<input checked="" type="radio"/>	<input type="radio"/>
Sport 	<input type="radio"/>	<input checked="" type="radio"/>	<input type="radio"/>	Express 15' 		<input checked="" type="radio"/>	<input type="radio"/>
R. Bebé 	<input type="radio"/>	<input checked="" type="radio"/>	<input type="radio"/>	Rápido 45' 		<input checked="" type="radio"/>	<input type="radio"/>
Jeans 	<input type="radio"/>	<input checked="" type="radio"/>	<input type="radio"/>	20°C		<input checked="" type="radio"/>	<input type="radio"/>
ECO 40-60 		<input checked="" type="radio"/>	<input type="radio"/>	VapCare 	<input type="radio"/>	<input checked="" type="radio"/>	<input type="radio"/>
Limp. tambor 							

- Necesario
- Opcional

# FUNCIONAMIENTO

## Recomendación de detergente

Recomendación de detergente	Tipo de tejido	Ciclos de lavado	Temperat. lavado°C
Detergente de alta resistencia con agentes blanqueadores y abrillantadores ópticos	Ropa blanca hecha de algodón o lino a prueba de ebullición	Algodón/Algodão  ECO 40-60 	40/60
Detergente de color sin blanqueador ni abrillantadores ópticos	Ropa de color hecha de algodón o lino	Algodón/Algodão 	20/40
Detergente de color o suave sin abrillantadores ópticos	Ropa de color hecha de fibras de fácil cuidado o materiales sintéticos	Algodón/Algodão  Sintéticos 	20/40
Detergente de lavado suave	Tejidos delicados, seda o viscosa	Sintéticos 	20
Detergente especial para lana	Lana	Lana/Lã 	20/40

### NOTA

- Es recomendable diluir los detergentes o suavizantes más espesos con agua para evitar que la entrada de detergente se bloquee y se desborde al llenarse de agua.
- escoja un tipo de detergente apropiado para las distintas temperaturas de lavado y obtenga el mejor rendimiento con menos consumo de agua y de energía.
- Para obtener los mejores resultados de lavado, es importante dosificar el detergente. Use una cantidad reducida si el tambor no está completamente lleno.
- Ajuste siempre la cantidad de detergente a la dureza del agua. Si es blanda, use menos detergente.
- Dosifique el detergente según el nivel de suciedad de las prendas.
- El detergente de alta concentración (compacto) requiere una dosificación especialmente exacta.

Los siguientes síntomas son signo de exceso de detergente:

- formación de mucha espuma
- resultados pobres de lavado y aclarado

Los siguientes síntomas son signo de falta de detergente:

- la colada se vuelve gris
- acumulación de depósitos de cal en el tambor, en la resistencia o en las prendas.

## Panel de control

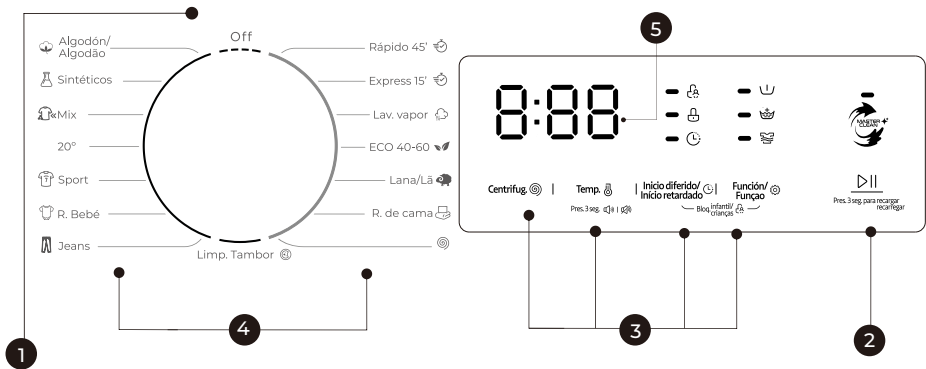

### 1 OFF

Apaga la lavadora.

### 2 Inicio/Pausa

Pulse el botón para iniciar o pausar el programa.

### 3 Opciones

Para seleccionar funciones adicionales, se iluminarán al seleccionarlas.

### 4 Programas

Disponibles según el tipo de prendas.

### 5 Pantalla

La pantalla muestra los ajustes, tiempo restante estimado, opciones y mensajes de estado.

### NOTA

- El gráfico es sólo de referencia, por favor refiérase al producto real como estándar.

# FUNCIONAMIENTO

## Pantalla

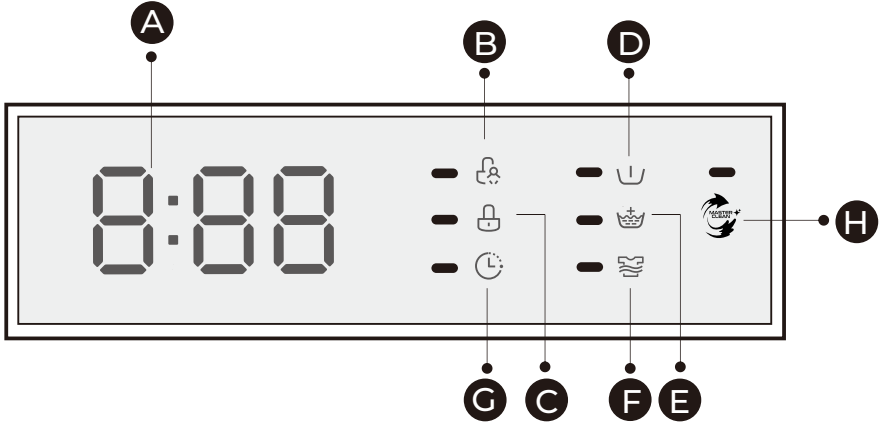

- A** Display
  - Tiempo lavado
  - 125
  - Velocidad centrifugado
  - 400
  - Fin
  - End
  - Tiempo diferido
  - 2H
  - Error
  - E30
  - Temp.
  - 30
- B** Bloqueo infantil
- C** Bloqueo puerta
- D** Prelavado
- E** Aclarado extra
- F** Lavado intensivo
- G** Diferido
- H** MASTER CLEAN

## Programas





Modelo: ADRA100; ADRA120

Programa	Carga (kg)		Tiempo mostrado(h:min)	
	10.0	12.0	10.0	12.0
Algodón/Algodão 	10.0	12.0	3:49	3:49
Sintéticos 	5.0	6.0	3:28	3:28
Mix 	10.0	12.0	1:30	1:30
20°C	5.0	6.0	1:11	1:11
Sport 	5.0	6.0	0:57	0:57
R. Bebé 	10.0	12.0	1:52	1:52
Jeans 	10.0	12.0	1:56	1:56
VapCare 	5.0	6.0	1:58	1:58
Centrifugado 	10.0	12.0	0:12	0:12
R. de cama 	10.0	12.0	1:48	1:48
Lana/Lã 	2.0	2.0	1:07	1:07
ECO 40-60 	10.0	12.0	3:59	4:00
Limp. tambor 	--	--	1:28	1:28
Express 15' 	2.0	2.0	0:15	0:15
Rápido 45' 	2.0	2.0	0:45	0:45

### NOTA





- Los parámetros de esta tabla son solo para referencia del usuario. Los parámetros reales pueden diferir de los indicados en la tabla anterior.

ADRA100

Ciclo	Capacidad nominal en kg	Ajuste de temperatura °C	Duración del ciclo en h:min	Consumo de energía en kWh/ciclo	Consumo de agua en litros/ciclo	Temperatura máxima °C <sup>1)</sup>	Humedad residual en %/Velocidad de centrifugado en rpm <sup>2)</sup>
Algodón/ Algodão 	10.0	60	3:54	1.726	85	60	53%/1400
Mix 	10.0	40	1:30	0.889	85	40	70%/800
20 °C	5.0	20	1:11	0.212	51	20	65%/1000
Express 15' 	2.0	Fría	0:15	0.030	31	Fría	70%/800
R. de cama 	10.0	40	1:48	0.920	85	40	65%/1000
ECO 40-60 <sup>3)</sup> 	10.0	--	3:59	0.895	67.0	41	53.9%/1350
	5.0	--	3:00	0.560	52.0	33	53.9%/1350
	2.5	--	3:00	0.232	41.5	23	53.9%/1350

- Los datos anteriores son sólo una referencia, pueden variar debido a cambios en las condiciones de uso reales.
- Los valores para programas que no sean el programa ECO 40-60 son solo indicativos.
- 20°C es capaz de limpiar ropa de algodón ligeramente sucia, a una temperatura nominal de 20°C, que cumple con el reglamento (UE) 2019/2023.
- Según la normativa EN 60456:2016/prA2019 con (EU)2019/2014, (EU)2019/2023, (EU)2021/340, (EU)2021/341, la nueva clase de eficiencia energética de la UE es: A Programa de prueba de energía: ECO 40-60. Resto: predeterminado. Media carga para máquina de 10.0Kg: 5.0Kg. Cuarto de carga para máquina de 10Kg: 2.5Kg.

ADRA120

Ciclo	Capacidad nominal en kg	Ajuste de temperatura °C	Duración del ciclo en h:min	Consumo de energía en kWh/ciclo	Consumo de agua en litros/ciclo	Temperatura máxima °C <sup>1)</sup>	Humedad residual en %/Velocidad de centrifugado en rpm <sup>2)</sup>
Algodón/ Algodão 	12.0	60	3:54	1.936	99	60	53%/1400
Mix 	12.0	40	1:30	1.006	99	40	70%/800
20 °C	6.0	20	1:11	0.224	58	20	65%/1000
Express 15' 	2.0	Cold	0:15	0.030	31	Cold	70%/800
R. de cama 	12.0	40	1:48	1.037	99	40	65%/1000
ECO 40-60 <sup>3)</sup> 	12.0	--	4:00	1.186	82.0	42	53.9%/1350
	6.0	--	3:00	0.618	58.0	32	53.9%/1350
	4.0	--	3:00	0.254	46.0	24	53.9%/1350

- Los datos anteriores son sólo una referencia, pueden variar debido a cambios en las condiciones de uso reales.
- Los valores para programas que no sean el programa ECO 40-60 son solo indicativos.
- 20°C es capaz de limpiar ropa de algodón ligeramente sucia, a una temperatura nominal de 20°C, que cumple con el reglamento (UE) 2019/2023.
- Según la normativa EN 60456:2016/prA2019 con (EU)2019/2014, (EU)2019/2023, (EU)2021/340, (EU)2021/341, la nueva clase de eficiencia energética de la UE es: A
- Programa de prueba de energía: ECO 40-60. Resto: predeterminado.
- Media carga para máquina de 12.0Kg: 6.0Kg. Cuarto de carga para máquina de 12Kg: 3.0Kg.

## Programas

- 1) La temperatura más alta alcanzada por la colada en el ciclo de lavado durante al menos 5 minutos.
- 2) La humedad residual después del ciclo de lavado en porcentaje de contenido de agua y la velocidad de centrifugado a la que se alcanzó.
- 3) El programa ECO 40-60 es capaz de lavar ropa de algodón normalmente sucia declarada lavable a 40°C o 60°C, juntos en el mismo ciclo. Este programa se utiliza para evaluar el cumplimiento del reglamento (UE) 2019/2023.

Los programas más eficientes en términos de consumo de energía son generalmente los que se realizan a temperaturas más bajas y de mayor duración. Cargar la lavadora doméstica hasta la capacidad indicada para los respectivos programas contribuirá a ahorrar energía y agua.

El ruido y el contenido de humedad restante están influenciados por la velocidad de centrifugado: cuanto mayor sea la velocidad de centrifugado en la fase de centrifugado, mayor será el ruido y menor el contenido de humedad restante.















### AVISO

- Si hay algún corte de corriente mientras la máquina está funcionando, se pone en marcha una memoria especial que almacena el programa seleccionado. La máquina continuará con el mismo programa cuando recupere corriente.



# FUNCIONAMIENTO

Programas disponibles según el tipo de tejidos:

















Programmes	
Algodón/ Algodão 	Tejidos resistentes al desgaste y al calor, de algodón o lino.
Rápido 45' 	Lavar rápidamente poca ropa y no muy sucia.
Sintéticos 	Lavado de artículos sintéticos, por ejemplo: camisas, abrigos, mezclas. Al lavar los tejidos de punto, se reducirá la cantidad de detergente debido a su estructura de hilo suelto y a la facilidad con que se forman burbujas.
R. bebé 	Para lavar ropa de bebé, puede limpiarla más profundamente y hacer que el enjuague sea más eficaz para proteger la piel del bebé.
Jeans 	Especial para pantalones vaqueros.
Mix 	Carga mixta compuesta por textiles de algodón y sintéticos.
20°C	Capaz de limpiar ropa de algodón ligeramente sucia, a una temperatura nominal de 20 °C.
Sport 	Lavar la ropa de deporte.
Express 15' 	Programa extra corto, adecuado para lavados con poca carga y no muy sucia.
R. de cama 	Especialmente diseñado para lavar prendas voluminosas
Lana/Lã 	Tejidos de lana o lana fina lavables a mano o a máquina. Programa de lavado especialmente suave para evitar el encogimiento, pausas de programa más largas (los tejidos reposan en el líquido de lavado).
Centrifugado 	Centrifuga y escurre el agua.
ECO 40-60 	Capaz de limpiar ropa de algodón de suciedad normal declarada lavable a 40 °C o 60 °C, juntos en el mismo ciclo.
VapCare 	El vapor es aplicable a las coladas diarias.
Limp. tambor 	Este programa está diseñado para limpiar el tambor y el tubo. Aplica una esterilización a alta temperatura de 90°C para que el lavado de la ropa sea más ecológico. Cuando se ejecuta este programa, no se puede añadir la ropa u otro tipo de lavado. Cuando se pone la cantidad adecuada de agente blanqueador de cloro, el efecto de limpieza del tambor será mejor. El cliente puede utilizar este programa regularmente según sus necesidades.

## ● NOTA

- El gráfico es sólo de referencia, refiérase al producto real como estándar.
- Cuando el programa haya finalizado, "End" parpadeará en la pantalla. Gire la rueda a la posición "Off".

# FUNCIONAMIENTO

## Opciones

Ciclo	Temperatura predet. (°C)	Velocidad predeterminada de centrifugado en rpm	Funciones adicionales
		1400	
Algodón/Algodão 	40	1400	   
Sintéticos 	40	1200	   
Mix 	40	800	   
20°C	20	1000	 
Sport 	20	800	  
R. Bebé 	60	1000	   
Jeans 	60	800	  
Limp. Tambor 	90	--	
Centrifugado 	--	1000	
R. de cama 	40	1000	   
Lana/Lã 	40	600	 
ECO 40-60 	--	1400	
VapCare 	40	1000	   
Express 15' 	Cold	800	
Rápido 45' 	20	800	 

### NOTA

Consulte la velocidad máxima de centrifugado, duración y otros detalles del programa ECO 40-60 en la ficha de producto. La tabla muestra las opciones que ofrece cada ciclo, y si algún ajuste no está disponible para algún programa.



### Centrifugado

La velocidad de centrifugado puede ajustarse pulsando el botón Centrifug. en los siguientes pasos: 1400:0-400-600-800-1000-1200-1400



### Inicio diferido/Inicio retardado

1. Seleccione un programa.
2. Pulse el botón Inicio diferido/Inicio retardado para elegir el tiempo de retardo entre 0 y 24h.
3. Pulse Inicio/Pausa para iniciar la función.



Seleccione programa



Ajuste el tiempo



Iniciar

Para cancelar el Inicio diferido/Inicio retardado, pulse el botón antes de iniciar el programa hasta que la pantalla muestre 0H. Si el programa ya ha comenzado, apague el aparato, vuelva a encenderlo y seleccione un programa nuevo.



### Prelavado

Función de lavado extra antes de que comience el ciclo de lavado principal para aumentar el rendimiento del lavado.

Nota: Es necesario añadir detergente al compartimento I.



### Aclarado extra

La colada se someterá a un aclarado adicional después de seleccionar esta función.



### Lavado intensivo

Seleccione esta función para la ropa muy sucia, puede aumentar el tiempo de lavado y la intensidad para aumentar el grado de limpieza.



### MASTER CLEAN

Cuando el piloto de la función MASTER CLEAN está encendido, esta función se activa automáticamente en el programa. La función se activará de manera automática durante cada ciclo de lavado y mantendrá su colada siempre limpia.



### Temperatura

La temperatura de lavado puede ajustarse pulsando el botón de Temp. en los siguientes pasos: Frío -20°C-30°C - 40°C- 60°C - 90°C.



## NOTA

### Contador de utilización

1. Desenchufe el equipo durante 10s y vuelva a conectarlo.
2. Encienda el equipo y dentro de 10s, por favor presione "Centrifug." y "Función/Função" en el panel de control simultáneamente durante 5s hasta que la pantalla del equipo muestre dígitos -- el valor puede indicar los tiempos de uso del equipo.
3. Repita el paso 1 de nuevo y el cliente puede reanudar el funcionamiento normal.

# FUNCIONAMIENTO



## Bloqueo infantil

Esta función evita que los niños hagan un uso indebido de los mandos.



Pulse "Inicio diferido/Inicio retardado" y "Función/Funcão" durante 3 segundos hasta que suene la alarma. El indicador del bloqueo infantil se encenderá.



## AVISO

Mientras el Bloqueo infantil está activado, la pantalla mostrará alternativamente "CL" y el tiempo restante.

Al pulsar cualquier otro botón, el indicador de Bloqueo infantil parpadeará. "CL" y "END" aparecerán alternativamente en la pantalla tras el fin del programa.

El Bloqueo infantil bloquea todos los botones excepto el Bloqueo infantil. Pulse los botones Inicio diferido/Inicio retardado y Función/Funcão para desactivar el Bloqueo infantil. Desactive el Bloqueo infantil antes de elegir un programa nuevo.



## Silenciar avisos



Seleccione un programa



Pulse el botón Temp. durante 3 segundos para silenciar los avisos

Para activar el sonido de los avisos, vuelva a pulsar el botón durante 3 segundos. El ajuste se mantendrá hasta que vuelva a cambiarlo.



## AVISO

- Tras silenciar la función timbre, los avisos dejarán de sonar.



## Recargar

Esta operación puede ejecutarse durante el proceso de lavado. Cuando el tambor todavía está girando y con gran cantidad de agua a alta temperatura, existen riesgos y la puerta se bloquea para que no pueda abrirse a la fuerza. Pulse ► durante 3 seg. para recargar hasta que se desbloquee y meta las prendas. Siga las siguientes instrucciones:

1. Espere hasta que el tambor deje de girar.
2. Abra la puerta.
3. Cierre la puerta tras introducir las prendas y pulse el botón Inicio/Pausa.



Pulse durante 3 segundos



Introduzca las prendas



Inicie

## Ficha del producto

Nombre distribuidor<sup>(a),(c)</sup>: EAS ELECTRIC

Dirección<sup>(a),(c)</sup>: P.I. San Carlos, Camino de la Sierra, S/N, Parcela 11 03370 Redován (Alicante) - ESPAÑA

Modelo<sup>(c)</sup>: ADRA100

Parámetros generales del producto

Parámetro	Valor	Parámetro	Valor	
Capacidad nominal en Kg <sup>(b)</sup>	10.0	Dimensiones en cm <sup>(a),(c)</sup>	Alto	85
			Ancho	60
			Fondo	53
Índice de eficiencia energética <sup>(b)</sup> (EEI <sub>w</sub> )	51.9	Clase de eficiencia energética <sup>(b)</sup>	A <sup>(d)</sup>	
Índice de eficiencia de lavado <sup>(b)</sup>	1.031	Índice de efectividad de aclarado (g/kg) <sup>(b)</sup>	5.0	
Consumo energético en kWh por ciclo para un ciclo ECO 40-60 de la lavasecadora en una combinación de cargas llenas y parciales. El consumo energético real dependerá de cómo se utilice el aparato.	0.513	Consumo de agua en litros por ciclo para un ciclo ECO 40-60 de la lavasecadora en una combinación de cargas llenas y parciales. El consumo de agua real dependerá de cómo se utilice el aparato y la dureza del agua.	52	
Temperatura máxima dentro del textil tratado <sup>(b)</sup> (°C)	Capacidad nominal	37	Contenido de humedad restante ponderado <sup>(b)</sup> (%)	53.9
	Media	33		
	Cuarto	23		
Velocidad de centrifugado <sup>(b)</sup> (rpm)	Capacidad nominal	1350	Índice de efectividad de centrifugado <sup>(b)</sup>	B <sup>(d)</sup>
	Media	1350		
	Cuarto	1350		
Duración del programa <sup>(b)</sup> (h:min)	Capacidad nominal	3:59	Tipo	Libre instalación
	Media	3:00		
	Cuarto	3:00		
Emisiones acústicas aéreas durante la fase de centrifugado en el ciclo de lavado ECO 40-60 en la capacidad nominal de lavado <sup>(b)</sup> (dB(A) re 1 pW)	72	Clase de emisiones acústicas aéreas durante la fase de centrifugado <sup>(b)</sup>	A <sup>(d)</sup>	
Modo apagado (W) si es aplicable	0.50	Modo en espera (W) si es aplicable	N/A	
Inicio diferido (W) si es aplicable	4.00	Modo en espera en red (W) si es aplicable	N/A	

Duración mínima de la garantía ofrecida por el proveedor<sup>(a),(c)</sup>: 3 años

Este aparato ha sido diseñado para liberar iones de plata durante el ciclo de lavado:

NO

Información adicional

Web donde se puede encontrar la información del punto 9 del Anexo II de la norma UE 2019/2023<sup>(1)</sup>: [www.ponjohnsonentuvida.es](http://www.ponjohnsonentuvida.es)

<sup>(a)</sup> Estos datos no se consideran relevantes para los propósitos del artículo 2(6) de la normativa EU 2017/1369.

<sup>(b)</sup> Para el programa ECO 40-60.

<sup>(c)</sup> Los cambios en estos puntos no deben ser considerados relevantes para los propósitos del párrafo 4 del artículo 4 de la norma UE 2017/1369.

<sup>(d)</sup> Si la base de datos automáticamente genera contenido definitivo en esta celda el proveedor no debe introducir ese dato

Nombre distribuidor<sup>(a),(c)</sup>: EAS ELECTRIC

Dirección<sup>(a),(c)</sup>: P.I. San Carlos, Camino de la Sierra, S/N, Parcela 11 03370 Redován (Alicante) - ESPAÑA

Modelo<sup>(a)</sup>: ADRA120

Parámetros generales del producto

Parámetro	Valor	Parámetro	Valor	
Capacidad nominal en Kg <sup>(b)</sup>	12.0	Dimensiones en cm <sup>(a),(c)</sup>	Alto	85
			Ancho	60
			Fondo	60
Índice de eficiencia energética <sup>(b)</sup> (EEI <sub>w</sub> )	52.0	Clase de eficiencia energética <sup>(b)</sup>	A <sup>(d)</sup>	
Índice de eficiencia de lavado <sup>(b)</sup>	1.031	Índice de efectividad de aclarado (g/kg) <sup>(b)</sup>	5.0	
Consumo energético en kWh por ciclo para un ciclo ECO 40-60 de la lavasecadora en una combinación de cargas llenas y parciales. El consumo energético real dependerá de cómo se utilice el aparato.	0.544	Consumo de agua en litros por ciclo para un ciclo ECO 40-60 de la lavasecadora en una combinación de cargas llenas y parciales. El consumo de agua real dependerá de cómo se utilice el aparato y la dureza del agua.	57	
Temperatura máxima dentro del textil tratado <sup>(b)</sup> (°C)	Capacidad nominal	42	Contenido de humedad restante ponderado <sup>(b)</sup> (%)	53.9
	Media	32		
	Cuarto	24		
Velocidad de centrifugado <sup>(b)</sup> (rpm)	Capacidad nominal	1350	Índice de efectividad de centrifugado <sup>(b)</sup>	B <sup>(d)</sup>
	Media	1350		
	Cuarto	1350		
Duración del programa <sup>(b)</sup> (h:min)	Capacidad nominal	4:00	Tipo	Libre instalación
	Media	3:00		
	Cuarto	3:00		
Emisiones acústicas aéreas durante la fase de centrifugado en el ciclo de lavado ECO 40-60 en la capacidad nominal de lavado <sup>(b)</sup> (dB(A) re 1 pW)	80.0	Clase de emisiones acústicas aéreas durante la fase de centrifugado <sup>(b)</sup>	C <sup>(d)</sup>	
Modo apagado (W) si es aplicable	0.50	Modo en espera (W) si es aplicable	1.00	
Inicio diferido (W) si es aplicable	4.00	Modo en espera en red (W) si es aplicable	N/A	

Duración mínima de la garantía ofrecida por el proveedor<sup>(a),(c)</sup>: 3 años

Este aparato ha sido diseñado para liberar iones de plata durante el ciclo de lavado:

NO

Información adicional

Web donde se puede encontrar la información del punto 9 del Anexo II de la norma UE 2019/2023<sup>(1)</sup>: [www.ponjohnsonentuvida.es](http://www.ponjohnsonentuvida.es)

<sup>(a)</sup> Estos datos no se consideran relevantes para los propósitos del artículo 2(6) de la normativa EU 2017/1369.

<sup>(b)</sup> Para el programa ECO 40-60.

<sup>(c)</sup> Los cambios en estos puntos no deben ser considerados relevantes para los propósitos del párrafo 4 del artículo 4 de la norma UE 2017/1369.

<sup>(d)</sup> Si la base de datos automáticamente genera contenido definitivo en esta celda el proveedor no debe introducir ese dato

# LIMPIEZA Y CUIDADO

## Limpieza y cuidado

### ADVERTENCIA

- Antes de empezar el mantenimiento, desenchufe el aparato y cierre el agua.

### Limpieza de la cubierta

Un mantenimiento adecuado del aparato puede prolongar su vida útil. La superficie puede limpiarse con detergentes neutros no abrasivos cuando sea necesario. Si hay algún desbordamiento de agua, use un paño para limpiarlo inmediatamente. No use ningún objeto punzante para limpiar la lavadora.

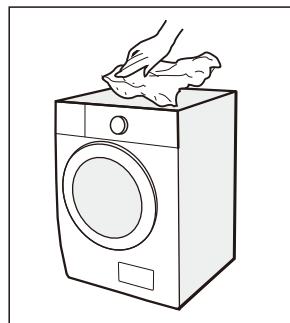

### AVISO

- No utilice ácido fórmico ni disolventes diluidos o equivalentes como alcohol u otros productos químicos.

### Limpieza del tambor

Limpe inmediatamente con detergente sin cloro el óxido que dejan en el tambor los objetos metálicos. No utilice nunca un estropajo de aluminio.

### NOTA

- No coloque ropa en el aparato durante la limpieza del tambor.

### Limpieza de la junta de la puerta y del cristal

Limpe el cristal y la junta después de cada lavado para quitar la pelusa y las manchas. Si se acumula pelusa, puede causar fugas. Retire las monedas, botones y otros objetos después de cada lavado. Limpe el cristal y la junta una vez al mes para garantizar un funcionamiento correcto del aparato.

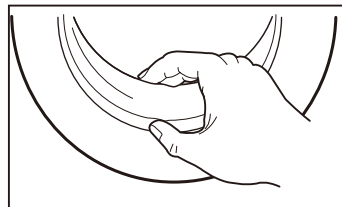

# LIMPIEZA Y CUIDADO

## Limpieza del filtro de entrada de agua

### ● NOTA

- Si entra menos cantidad de agua, debe limpiarse el filtro de entrada.

1. Cierre la llave de paso y saque la manguera de admisión.

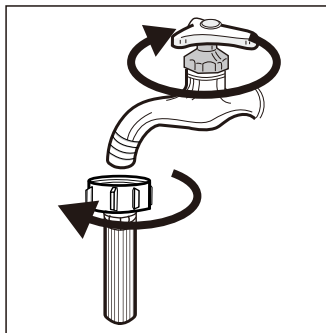

2. Limpie el filtro con un cepillo.

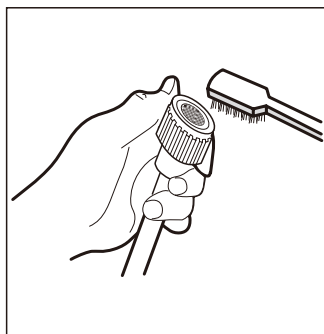

3. Desensrosque la manguera de suministro de agua de la parte trasera de la lavadora. Saque el filtro con unas pinzas alargadas.

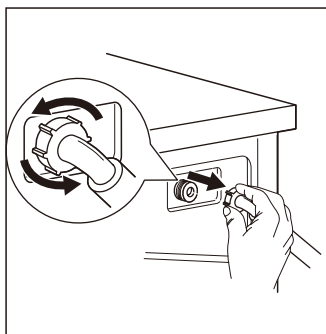

4. Limpie el filtro con un cepillo.

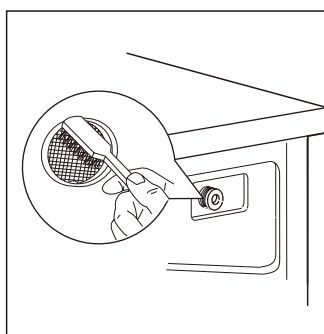

5. Vuelva a colocar el filtro y la manguera de suministro de agua.
6. Limpie el filtro de admisión cada 3 meses para garantizar un funcionamiento normal del aparato.



# LIMPIEZA Y CUIDADO

## Limpieza del dispensador de detergente

1. Pulse sobre el bloqueo  de la tapa del suavizante y saque el cajetín dispensador. Limpie el interior con un cepillo.
2. Quite la tapa del suavizante y el cajetín y limpie ambos con agua.
3. Vuelva a colocar la tapa del suavizante y el cajetín en su hueco correspondiente.

1. Pulse el bloqueo y saque el cajetín dispensador

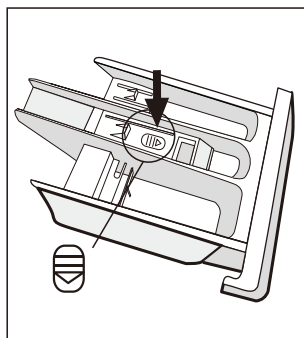

2. Limpie el cajetín y la tapa del suavizante bajo el agua

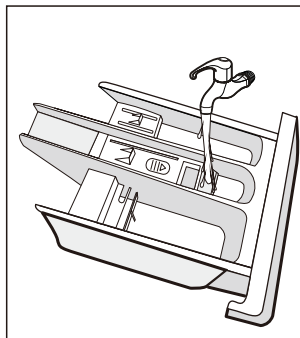

3. Limpie el hueco con un cepillo suave

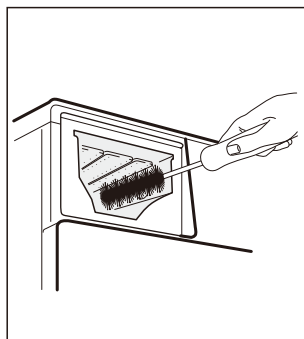

4. Coloque de nuevo el dispensador

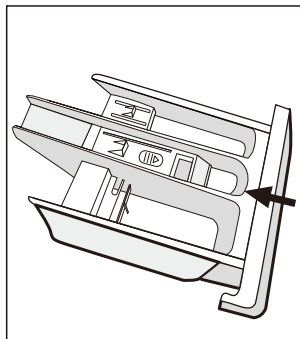

### NOTA

- No utilice agentes abrasivos o cáusticos para limpiar los plásticos.
- Limpie el dispensador de detergente cada 3 meses para garantizar el funcionamiento normal del aparato.

# LIMPIEZA Y CUIDADO

## Limpieza del filtro de la bomba de desagüe

### ADVERTENCIA

- Asegúrese de que la lavadora ha terminado el ciclo de lavado y está vacía. Apáguela y desenchúfela antes de limpiar el filtro de la bomba de desagüe.
- Tenga cuidado con el agua caliente. Deje que el agua se enfríe. Riesgo de quemaduras.
- Limpie el filtro cada 3 meses para garantizar un funcionamiento normal.

1. Abra la tapa inferior

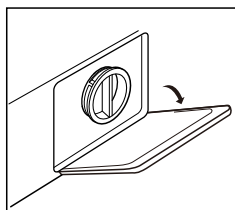

2. Abra el filtro girándolo como se indica en la imagen

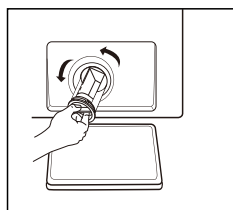

3. Retire cualquier objeto extraño

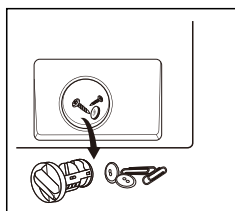

4. Cierre la tapa inferior

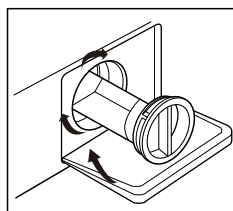

### ATENCIÓN

- Cuando el aparato está en uso y dependiendo del programa seleccionado puede haber agua caliente en la bomba. No quite nunca la tapa de la bomba durante un ciclo de lavado, espere siempre a que el aparato haya terminado el ciclo y esté vacío. Cuando vuelva a colocar la tapa, asegúrese de que está bien apretada.

# RESOLUCIÓN DE PROBLEMAS

Si el aparato no funciona, consulte esta tabla para encontrar una solución al problema. Si no consigue solucionarlo, póngase en contacto con el servicio técnico.

Descripción	Razón	Solución
La lavadora no se pone en marcha	La puerta no está bien cerrada. Hay ropa atascada.	Cierre la puerta y compruebe que la ropa no está atascada.
La puerta no se abre	Se ha activado el bloqueo de seguridad	Desconecte la lavadora y reiníciela.
Fuga de agua	Las conexiones no están apretadas	Compruebe y apriete las tuberías de agua. Limpie el tubo de desagüe.
Restos de detergente en el cajetín	El detergente se humedece o se aglomera	Limpie y seque el cajetín de detergente.
El indicador o la pantalla no se encienden	La placa de circuito o el arnés tienen problema de conexión.	Apáguela y compruebe si el enchufe está bien conectado.
Ruido anormal	Los tornillos de transporte siguen puestos. El suelo no es sólido o plano.	Compruebe si se han retirado los tornillos de fijación. Compruebe que la lavadora está instalada en un suelo sólido y nivelado.

## Códigos de error

Descripción	Razón	Solución
<b>E30</b>	La puerta no se ha cerrado correctamente	Cierre bien la puerta y reinicie.
<b>E10</b>	Problema de admisión de agua durante el lavado	Compruebe la presión de agua. Enderece la tubería de agua. Limpie el filtro de la válvula de entrada.
<b>E21</b>	Exceso de tiempo de drenaje	Compruebe si el desagüe está bloqueado.
<b>E12</b>	Desbordamiento de agua	Reinicie el aparato.
<b>EXX</b>	Otros	Reinicie el aparato o llame al servicio técnico.

# DISPOSICIÓN DE ELIMINACIÓN

 <p><b>ELIMINACIÓN:</b> No elimine este producto como residuos municipales sin clasificar. Es necesario recoger estos residuos por separado para un tratamiento especial.</p>	<p>Según la directiva europea 2012/19/UE de residuos de aparatos eléctricos y electrónicos (RAEE), los electrodomésticos no pueden ser arrojados en los contenedores municipales habituales; tienen que ser recogidos selectivamente para optimizar la recuperación y reciclado de los componentes y materiales que los constituyan y reducir el impacto en la salud humana y el medio ambiente.</p> <p>El símbolo del cubo de basura tachado se marca sobre todos los productos para recordar al consumidor la obligación de separarlos para la recogida selectiva. El consumidor debe contactar con la autoridad local o con el vendedor para informarse en relación a la correcta eliminación de su electrodoméstico.</p>
--	--

## Atención al cliente

Las piezas de repuesto para su electrodoméstico están disponibles durante un mínimo de 10 años siguiendo los requisitos de diseño ecológico del ANEXO II de la normativa 2019/2023 de la comisión de la UE.

En caso de duda, póngase en contacto con nuestro centro local de atención al cliente.

### ADVERTENCIA

Riesgo de descarga eléctrica

- Nunca intente reparar un aparato averiado usted mismo. Puede poner en riesgo su vida y la de otros que lo usen. Las reparaciones solo pueden realizarlas especialistas autorizados.
- Una reparación incorrecta anula la garantía y no se reconocerán los daños causados por ésta.

## Transporte

### PASOS IMPORTANTES PARA MOVER EL APARATO

- Desenchufe el aparato y cierre la entrada de agua.
- Compruebe si la puerta y el dispensador están bien cerrados.
- Retire la manguera de entrada y la de desagüe de la instalación del hogar.
- Deje que el agua se drene por completo del aparato (véase "Limpieza del filtro de la bomba de desagüe).
- Importante: Vuelva a instalar los 4 tornillos de transporte en la parte trasera del aparato.
- El aparato es pesado, transpórtelo con cuidado. Nunca lo sujete de ninguna de sus partes sobresalientes y no use la puerta como asa de transporte.

## CONDICIONES DE LA GARANTÍA

Este aparato tiene una garantía de reparación de tres años, a partir de la fecha de venta, contra todo defecto de funcionamiento proveniente de la fabricación, incluyendo mano de obra y piezas de recambio. Para justificar la fecha de compra será obligatorio presentar la factura o ticket de compra. Las condiciones de esta garantía se aplican únicamente a España y Portugal. Si ha adquirido este producto en otro país, consulte con su distribuidor las condiciones aplicables.

## EXCLUSIONES DE LA GARANTÍA

1. Mandos a distancia, gomas de admisión de desagüe, atranques y juntas de puertas, burletes.
2. Daños en esmaltes, pinturas, niquelados, cromados, oxidaciones u otro tipo de piezas o componentes estéticos que no afecten al funcionamiento interno del aparato.
3. Daños en piezas de desgaste por uso, corrosión u oxidación, ya sea causada por el uso normal del aparato o deterioro acelerado por circunstancias ambientales o climáticas no propicias. No aptos para uso en exterior.
4. Daños en piezas frágiles de cristal, cristal vitrocerámico, plásticos, manetas, cerrillos, puertas o bombillas cuando su fallo o rotura no sea atribuible a un defecto de fabricación.
5. Averías producidas por causas fortuitas o siniestros de fuerza mayor, o como consecuencia de un uso anormal, negligente o inadecuado del aparato.
6. Responsabilidades civiles de cualquier naturaleza.
7. Daños consecuenciales al aparato siempre que estos no hayan sido provocados por una avería interna de funcionamiento.
8. Mantenimientos o conservación del aparato: revisiones periódicas, ajustes y engrases.
9. Las averías que pueden sufrir los accesorios y complementos, adaptadores, cables externos, bolsas, recambios sueltos de todo tipo, lámparas, así como cualquier pieza considerada consumible por el fabricante.
10. Averías causadas por una instalación incorrecta o no legal, ventilación inadecuada, falta de toma de tierra en la vivienda, alteraciones de corriente, modificaciones inapropiadas o utilización de piezas de recambio no originales.
11. Electrodomésticos que se utilicen en aplicaciones industriales o para fines comerciales.
12. Electrodomésticos con número de serie ilegible o alterado.
13. Defectos o averías producidas como consecuencia de arreglos, reparaciones, modificaciones, o desarme de la instalación del aparato por el usuario o por un técnico no autorizado por el fabricante, o como resultado del incumplimiento manifiesto de las instrucciones de uso y mantenimiento del fabricante.
14. Durante el periodo de garantía es imprescindible conservar todos los manuales junto con el equipo. Si el equipo se vende, dona o regala, se debe entregar el manual y todos los documentos relacionados al nuevo usuario. Si alguno de estos se perdiera, no podrá ser reclamada su reposición.
15. Las averías que tengan su origen o sean consecuencia directa o indirecta de: contacto con líquidos, productos químicos y otras sustancias, así como de condiciones derivadas del clima o el entorno: terremotos, incendios, inundaciones, calor excesivo o cualquier otra fuerza externa, como insectos, roedores y otros animales que puedan tener acceso al interior de la máquina o sus puntos de conexión.
16. Daños derivados de terrorismo, motín, alboroto o tumulto popular, manifestaciones y huelgas legales o ilegales; hechos de actuaciones de la Fuerzas Armadas o de los Cuerpos de Seguridad del Estado en tiempos de paz; conflictos armados y actos de guerra (declarada o no); reacción o radiación nuclear o contaminación radiactiva; vicio o defecto propio de los bienes; hechos calificados por el Gobierno de la Nación como de "catástrofe o calamidad nacional".

**El diseño y las especificaciones están sujetos a cambios  
sin previo aviso para la mejora del producto.**

# CONTENTS

EN

3 SAFETY INSTRUCTIONS  
3 Safety Instructions

---

7 SPECIFICATIONS

8 PRODUCT OVERVIEW

9 QUICK START GUIDE

12 PRODUCT INSTALLATION

16 OPERATION INSTRUCTIONS

31 CLEANING AND MAINTENANCE

---

35 TROUBLE SHOOTING

36 DISPOSAL AND RECYCLING

38 WARRANTY

# SAFETY INSTRUCTIONS

## Intended Use

The product is intended only for home use and for textiles in household amounts suitable for washing. This appliance is for indoor use only and not intended for built in use. Only use according to these instructions. The appliance is not intended for commercial use.

Any other use is considered as improper use. The producer is not responsible for any damage or injury that may result from it.

This appliance is intended to be used in household and similar applications such as:

- Staff kitchen areas in shops, offices and other working environments;
- Farm houses;
- By clients in hotels, motels and other residential type environments;
- Bed and breakfast type environments;
- Areas for communal use in blocks of flats or in launderettes.

## Explanation of Symbols



### DANGER

This symbol indicates that there are dangers to the life and health of persons due to extremely flammable gas.



### WARNING OF ELECTRICAL VOLTAGE

This symbol indicates that there is a danger to life and health of persons due to voltage.



### WARNING

The signal word indicates a hazard with a medium level of risk which, if not avoided, may result in death or serious injury.



### CAUTION

The signal word indicates a hazard with a low degree of risk which, if not avoided, may result in minor or moderate injury.



### NOTE

The signal word indicates important information (e.g. damage to property), but not danger.



### OBSERVE INSTRUCTIONS

This symbol indicates that a service technician should only operate and maintain this appliance in accordance with the operating instructions.

Please read the following safety information thoroughly and follow it strictly to minimize the risk of fire or explosion, electric shock and to prevent property damage, personal injury or loss of life. Failing to follow these instructions shall void any warranty.

This appliance is not intended for use by persons (including children) with reduced physical, sensory or mental capabilities, or lack of experience and knowledge, unless they have been given supervision or instruction concerning use of the appliance by a person responsible for their safety.



## WARNING: Electric Shock Hazard

- If the supply cord is damaged, it must be replaced by the manufacturer, its service agent or similarly qualified persons in order to avoid a hazard.
- If the machine is damaged, it must not be operated unless repaired by the manufacturer, its service agent or similarly qualified persons.
- Risk of electric shock!
- The appliance can be used by children aged from 8 years and above and persons with reduced physical, sensory or mental capabilities or lack of experience and knowledge if they have been given supervision or instruction concerning use of the appliance in a safe way and understand the hazards involved. Children shall not play with the appliance. Cleaning and user maintenance shall not be made by children without supervision.
- Children should be supervised that they do not play with the appliance.
- Children 3 years and under shall be kept away from the appliance or continuously supervised.
- Animals and children may climb into the machine. Check the machine before every operation.
- Do not climb or sit on the appliance.

## Installation Location and Surrounding

- All washing and additional substances are to be kept in a safe place out of the reach of children.
- Do not install the machine on a carpet floor.
- The obstruction of the openings by a carpet can damage the machine.
- Keep the appliance clear from heating sources and direct sunlight to avoid plastic and rubber parts to corrode.
- Do not use the appliance in humid environments or rooms containing explosive or caustic gas. In case of water leakage or water splashes, let the appliance dry in the open air.
- The appliance must not be installed behind a lockable door, a sliding door or a door with a hinge on the opposite side to that of the machine .
- Do not operate the machine in rooms with a temperature of below 5°C. This can cause damages to parts of it. If it is unavoidable, make sure to drain the water completely from the appliance after every use (see“Maintenance - Cleaning of drain pump filter”) to avoid damages caused by frost.
- Never use flammable sprays or substances in the immediate proximity of the appliance.

## Installation

- Remove all packaging material and transport bolts before using the appliance. Otherwise, serious damage may result.
- This appliance is equipped with a single inlet valve and can be connected to the cold water supply only.
- Mains plug must be accessible after installation.
- Before washing clothes for the first time, the product shall be operated once throughout all the procedures without any clothes inside.
- Before using the machine, the product shall be calibrated.
- Do not put any excessively heavy objects on the appliance, like water containers or heating devices.

# SAFETY INSTRUCTIONS

- The new hose-sets supplied with the appliance are to be used and that old hose-sets should not be reused.
- Max. Inlet water pressure 1 MPa. Min. inlet water pressure 0.05 MPa.

## Electrical Connection

- Make sure the supply cable is not trapped by the machine, or it can get damaged.
- Connect the product to a grounded outlet protected by a fuse complying with the values in the "Technical specifications" table. The grounding installation has to be made by a qualified electrician. Ensure that the machine is installed in accordance with the local regulations.
- Water and electrical connections must be carried out by a qualified technician in accordance with the manufacturer's instructions and local safety regulations.



## WARNING:

- Don't use multiple plugs or extension cords.
- The appliance must not have an external switching device such as a timer or connected to a circuit that is regularly switched on and off.
- Do not pull the plug out of the mains outlet if there is flammable gas around.
- Never pull out power plug with wet hands.
- Always pull at the plug, not at the cable.
- Always unplug the appliance if it is not being used.

## Water Connections

- Check the connections of the water inlet tubes, the water tap and the outlet hose for possible problems due to changes of water pressure. If the connections loosen or leak, close the water tap and get it repaired.
- Do not use the appliance before the pipes and hoses are installed properly by qualified persons.
- Glass door may become very hot during the operation. Keep children and pets far away from the machine while it is operating.
- The water inlet and outlet hoses have to be safely installed and remain undamaged.
- Otherwise, water leakage can occur.
- Do not remove the drain pump filter while there is still water in the appliance. Big quantities of water can leak out, and there is a risk of scalding due to hot water.

## Operation and Maintenance

- Never use any flammable, explosive or toxic solvents. Do not use gasoline and alcohol etc. as detergents. Only select detergents that are suitable for machine washing.
- Make sure that all pockets are emptied. Sharp and rigid items such as coins, brooches, nails, screws, stones etc. may cause serious damages to this machine.
- Remove all objects from pockets such as lighters and matches before use the appliance. Thoroughly rinse items that have been washed by hand.

- Items that have been soiled with substances such as cooking oil, acetone, alcohol, petrol, kerosene, spot removers, turpentine, wax and wax removers should be washed in hot with an extra amount of detergent before being dried in the appliance.
- Items containing foam rubber (latex foam), shower caps, water proof textiles, rubber backed articles and clothes or pillows fitted with foam rubber pads should not be washed in the machine.
- Fabric softeners or similar products should be used as recommended in their instructions.
- Never try to open the door forcefully.
- The door will unlock shortly after the end of a cycle.
- Please do not close the door with excessive force. If it is found difficult to close the door, please check if the clothes are properly inserted and distributed.
- Always unplug the appliance and close the water tap before cleaning and maintenance and after each use.
- Never pour water over the appliance for cleaning purpose. Risk of electric shock!
- Repairs shall only be carried out by the manufacturer, its service agent or similarly qualified persons in order to avoid a hazard.
- The producer will not be responsible for damages caused by the intervention of not authorized persons.

## Transport

- Before Transport:
  - Bolts shall be reinstalled to the machine by a specialized person;
  - Accumulated water shall be drained out of the machine.
- This appliance is heavy. Transport with care. Never hold any protruding part of the machine when lifting. The machine door can not be used as a handle.

Model	Washing capacity
ADRA100	10.0kg
ADRA120	12.0kg

# SPECIFICATIONS

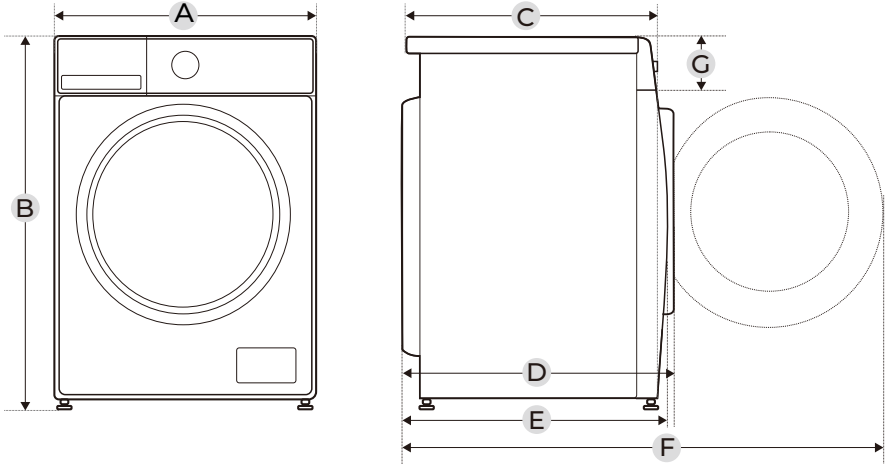

Model	ADRA100	ADRA120
Power Supply	220-240V~,50Hz	
MAX. Current	10A	
Standard Water Pressure	0.05MPa~1MPa	
Washing Capacity	10.0kg	12.0kg
<b>Dimension</b>		
A	595mm	595mm
B	850mm	850mm
C	530mm	595mm
Weight	65kg	73kg
Rated Power	2000W	2000W
<b>Reference Dimension</b>		
D	600mm	660mm
E	540mm	641mm
F	1045mm	1105mm
G	135mm	135mm

# PRODUCT OVERVIEW

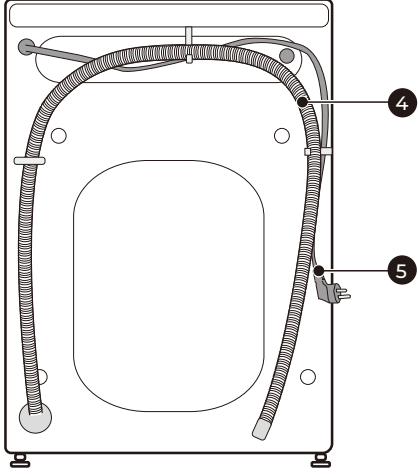
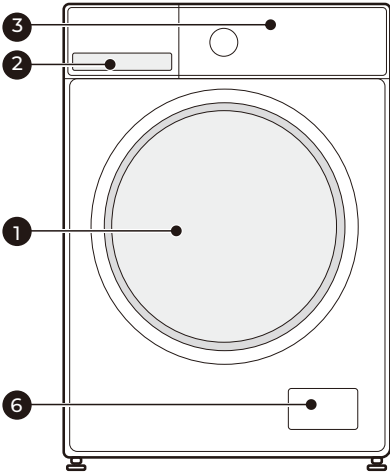

1	Door
2	Detergent dispenser
3	Control panel

4	Drain hose
5	Power supply cord
6	Service flap

**NOTE**

The product picture is for illustration only, please refer to real product as reference.

## Accessories

4 x Cover caps

1 x Supply hose cold water

1 x Owner's manual

Acoustic sponge (optional)

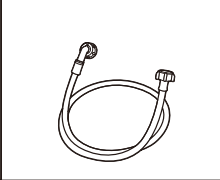
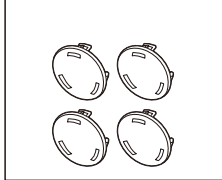

# QUICK START GUIDE



## CAUTION

- Before washing, please make sure the machine is installed properly.
- Your appliance was thoroughly checked before it left the factory. To remove any residual water and to neutralize potential odors, it's recommended to clean your appliance before first use. For this reason, recommended to clean the inner drum by running the "Limp. Tambor" or other program with the optional temperature of 90°C.  
Be careful not to put laundry and detergent in the machine.



## Calibration

It's recommended to calibrate the machine, so that provide the best performance. The appliance is able to detect the amount of laundry loaded. This function is optimizing the product performance by minimizing energy and water consumption, saving you money and time. For this reason it's recommended to calibrate the appliance for best use.

- 1- Remove all accessories from the drum and close the door;
- 2- Insert the mains plug to the socket;
- 3- Switch on the washing machine, and within 10 seconds, press "Centrifug." continuously (normally 3 seconds) until "t19" is displayed on the knob.
- 4- Press  to start the appliance, initially "---" is displayed, and then "\*\*\*\*" (such as "126") is displayed to indicate the real time drum speed. When the number reaches a certain value (stop changing), it means the washing machine is successfully calibrated.

## 1. Before Washing

1. Plug in

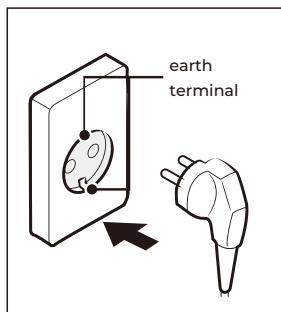

2. Open tap

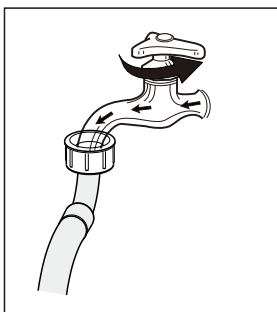

3. Load

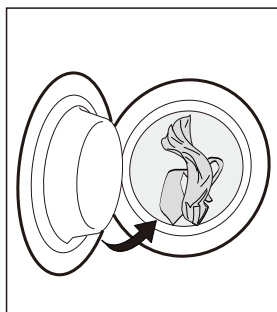

4. Close door

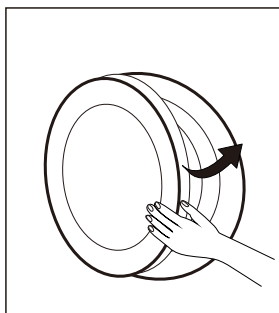

5. Add detergent

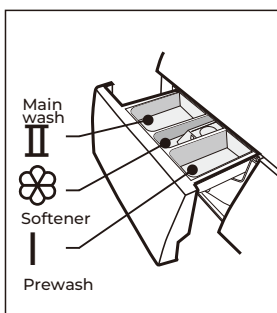

### NOTE

Detergent need to be added in compartment I if the pre-wash function is selected.

## 2. Washing

1. Select programme

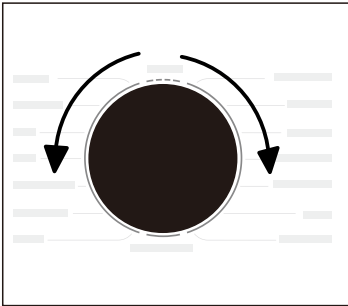

2. Select function or remain default settings

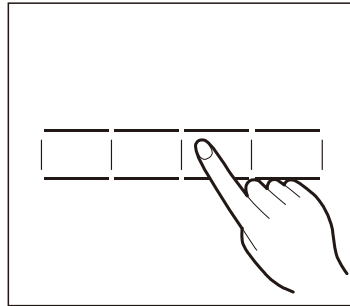

3. Press Start/Pause to start the program

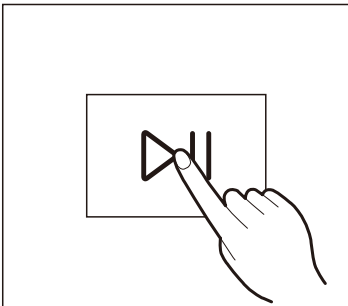

### NOTE

1 : If default is selected, step 2 can be skipped.

2: The function button line chart is for reference only, please refer to real product as standard.

## 3. After Washing

Buzzer beep and “End” on display.



# PRODUCT INSTALLATION

## Tools Needed If Installation By Yourself (not include)

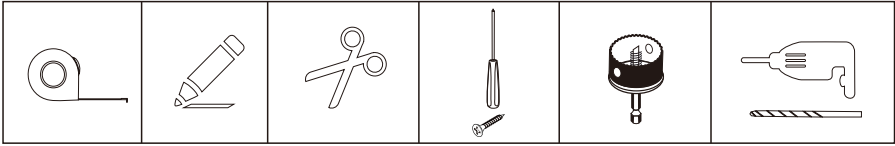

## Installation Area

### WARNING

- Stability is important to prevent the product from wandering!
- Make sure the machine is standing leveled and stable.
- Make sure that the product does not stand onto the power cord.
  - Make sure to maintain the minimum distances from the walls as shown in the picture.

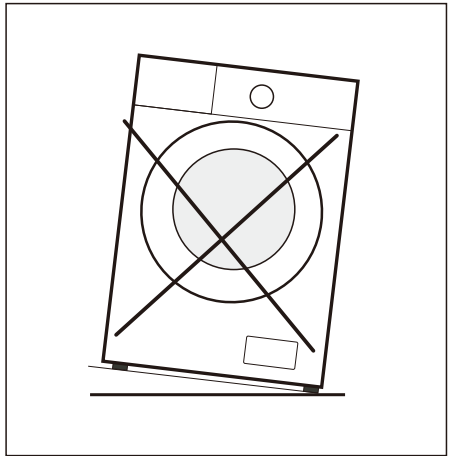
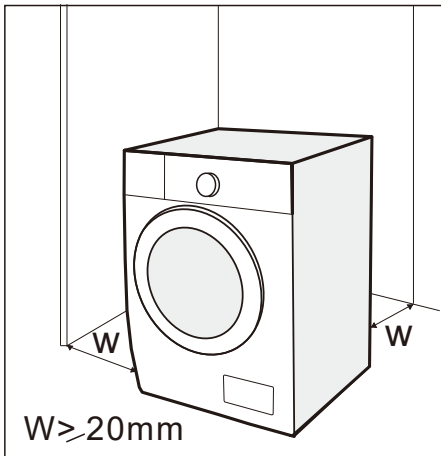

Before installing the machine, the location characterized as follows shall be selected:

1. Rigid, dry, and level surface.
2. Avoid direct sunlight.
3. Sufficient ventilation.
4. Room temperature is above 5 °C .
5. Keep far away from the heat sources such as coal or gas burning appliances.

## Unpacking the Machine

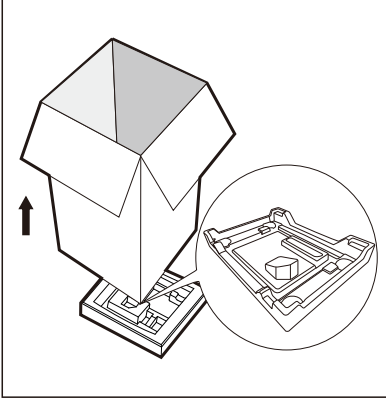

### WARNING

- Packaging material (e.g. Films, Styrofoam) can be dangerous for children.
- There is a risk of suffocation ! Keep all packaging well away from children.

1. Remove the cardboard box and styrofoam packing.
2. Lift the machine and remove the base packaging.
3. Remove the tape securing the power supply cord and drain hose.
4. Remove the inlet hose from the drum.

## Remove Transport Bolts

### WARNING

You must remove the transport bolts from the backside before using the product.

1. Loosen the 4 transport bolts with a spanner.

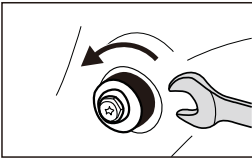

2. Remove the bolts including the rubber parts and keep them for future use.

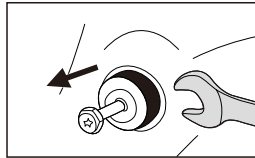

3. Close the holes using the cover caps.

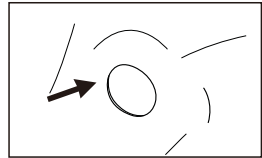

# PRODUCT INSTALLATION

## Levelling the Machine

### ⚠ WARNING

The lock nuts on all four feet must be screwed tightly against the housing.

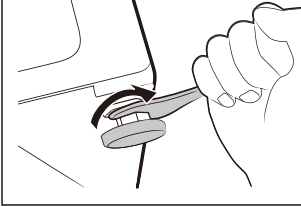

1. Loosen the lock nut.
2. Turn the foot until it reaches the floor.
3. Adjust the legs and lock the nuts with a spanner. Make sure the machine is level using a spirit level.

## Connect the Water Supply Hose

### ⚠ WARNING

To prevent leakage or water damage, follow the instructions in this chapter.

- Do not kink, crush or modify water inlet hose.

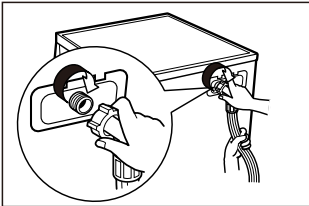

Connect the water supply hose to the water inlet valve and a water tap with cold water as indicated.

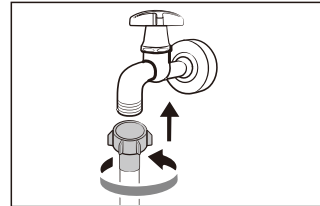

### ● NOTE

- Connect manually, do not use tools. Check if the connections are tight.

## Drain Hose

### ⚠ WARNING

- Do not kink or protract the drain hose.
- Position drain hose properly, otherwise damage might result in water leakage. It is not allowed to remove the buckle of drain pipe.

There are two ways to place the end of drain hose:

1. Put it into the water trough.

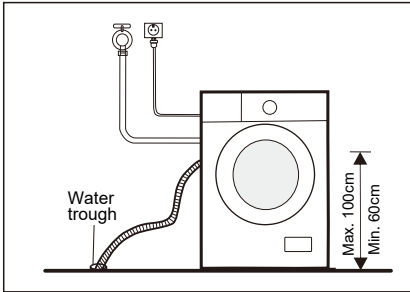

2. Connect it to the branch drain pipe of the trough.

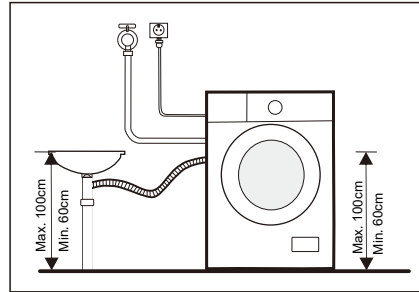

## Acoustic Sponge

### NOTE

- Please make sure to assemble the acoustic sponges, which can effectively reduce the noise caused by the machine while working, in order to provide you with a more peaceful and quiet living environment.

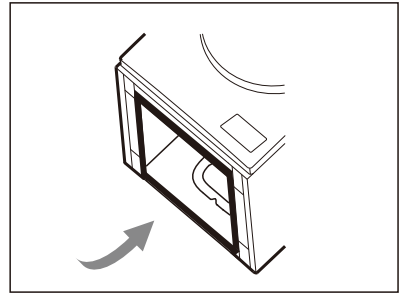
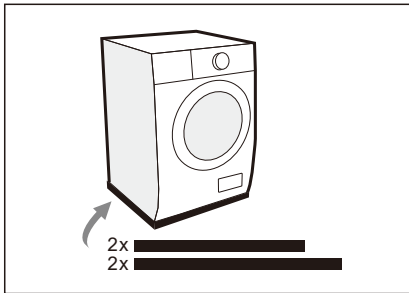

1. Get the machine laid on the floor, using some soft material like foam or clothes between the machine and floor for a protection;
2. Stick the 2x longer sponges to the longer bottom edges of machine, and the 2x shorter sponges to the shorter bottom edges.

# OPERATION INSTRUCTIONS

## Before Each Washing

- The ambient temperature of the machine should be 5°C-40°C. If used under 0°C, the inlet valve and draining system may be damaged. If the machine is installed under freezing conditions, it should be transferred to normal ambient temperature to ensure the water supply hose and drain hose can unfreeze before use.
- Please check your laundry care labels and the detergent use instructions before wash. Use non-foaming or less-foaming detergent suitable for machine properly.

1. Take all items out of the pockets

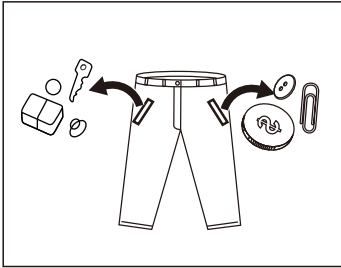

2. Sort laundry according to color and textile type

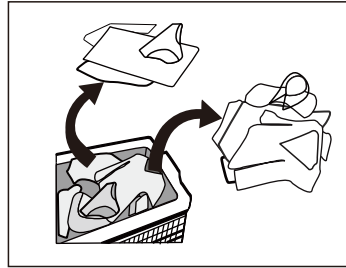

3. Tie together long textile strips and belts, close zips and button

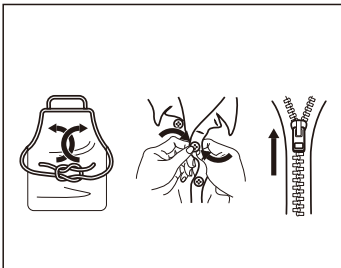

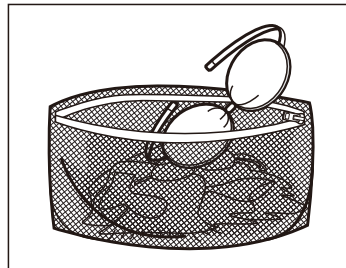

4. Put small items into a laundry bag



### ⚠ WARNING

- Do not wash or dry articles that have been cleaned in, washed in, soaked in, or dabbed with combustible or explosive substances like wax, oil, paint, gasoline, alcohol, kerosene, and other flammable materials.
- Washing single clothes items may easily create big eccentricity. Therefore it is suggested to add one or two more laundry items to the wash so that spin can be done smoothly.
- Do not wash, spin water-proof seats, mats ,or clothing.





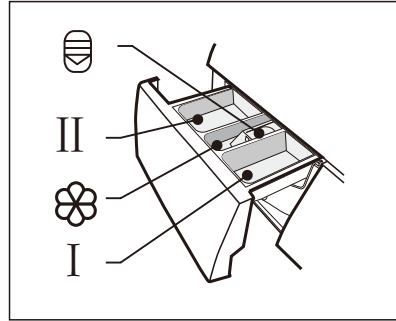













## Detergent Dispenser

- I Pre wash
- II Main wash
-  Softener
-  Release button to pull out the dispenser



### CAUTION







- Detergent only need to be added in “compartment I” after selecting pre-wash function.

Programme	I	II / 		Programme	I	II / 	
Algodón/Algodão  ○	●	○	○	(Spin only)  ⊙			
Sintéticos  ○	●	○	○	R. de cama  ○	○	●	○
Mix  ○	●	○	○	Lana/Lã  ●		●	○
Sport  ○	●	○	○	Express 15'  ●		●	○
R. Bebé  ○	●	○	○	Rápido 45'  ●		●	○
Jeans  ○	●	○	○	20°C ●		●	○
ECO 40-60  ●	●	○	○	VapCare  ○	○	●	○
Limp. tambor  ⊙							

- Means must
- Means optional

# OPERATION INSTRUCTIONS

## Detergent Recommendation

Recommended washing detergent	Type of laundry and textile	Wash cycles	Washing temp. °C
Heavy-duty detergent with bleaching agents and optical brighteners	White laundry made from boil-proof cotton or linen	Algodón/Algodão  ECO 40-60 	40/60
Colour detergent without bleaching agent and optical brighteners	Coloured laundry made from cotton or linen	Algodón/Algodão 	20/40
Color or mild detergent without optical brighteners	Coloured laundry made from easy care fibres or synthetic materials	Algodón/Algodão  Sintéticos 	20/40
Mild washing detergent	Delicate textiles, silk, viscose	Sintéticos 	20
Special wool detergent	Wool	Lana/Lã 	20/40

### NOTE

- Agglomerating or ropy detergent or additive can be diluted in some water before pouring it into the detergent dispenser, to avoid its inlet to get blocked and thus cause a water overflow.
- Please choose the suitable type of detergent to get a maximum of washing performance and a minimum of water and energy consumption.
- To achieve the best cleaning result a proper detergent dosing is important.
- Use a reduced detergent amount if the drum is not filled completely.
- Always adjust the amount of detergent to the water hardness, if your tap water is soft, use less detergent.
- Dose according to how dirty your laundry is, less dirty clothes require less detergent.
- Highly concentrated (compact detergent) requires particularly accurate dosing.

Following symptoms are a sign of detergent overdosing:

- heavy foam formation
- poor washing and rinsing result

Following symptoms are a sign of detergent under dosing:

- laundry turns grey
- built-up of limescale deposits on the drum, the heating element and/or the laundry

# Control Panel

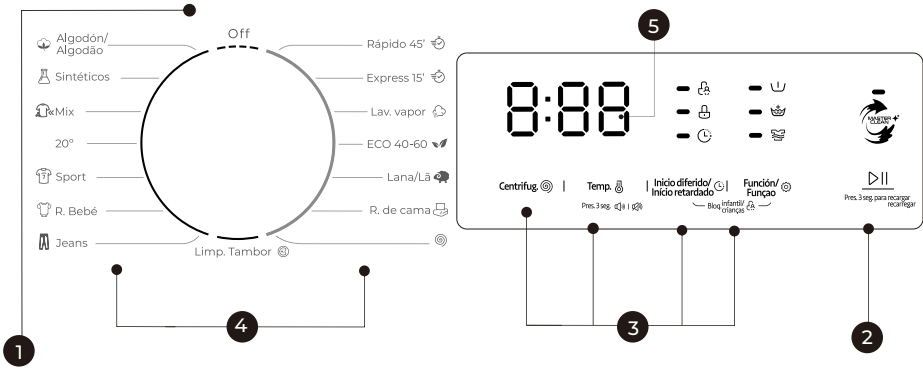

## 1 OFF

Turn the appliance off.

## 2 Start/Pause

Start or pause your programme.

## 3 Option

This allows you to select additional functions and will light when selected.

## 4 Programmes

Available according to the laundry type.

## 5 Display

The display shows settings, estimated remaining time, options and status messages.

## NOTE

- The Chart is reference only, please refer to real product as standard.



# OPERATION INSTRUCTIONS

## Display

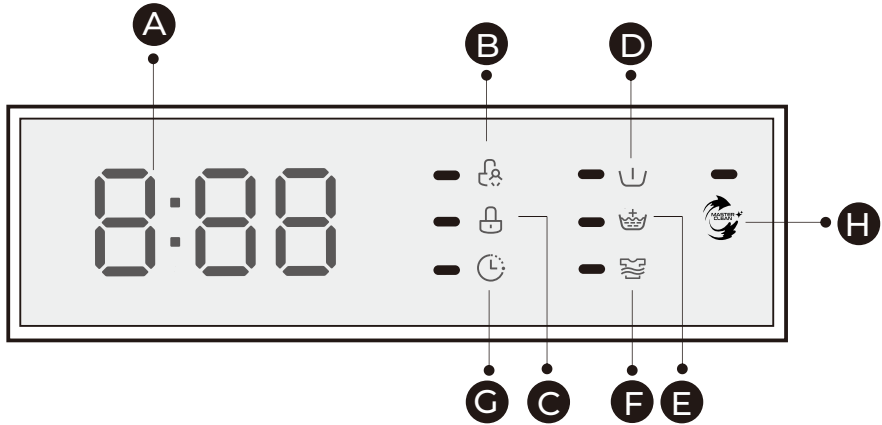

### A Display

Wash Time  
125  
Speed  
400  
End  
End

Delay Time  
2H  
Error  
E30  
Temp.  
30

### B Child Lock

### C Door Lock

### D Pre Wash

### E Extra Rinse















### F Strong Wash

### G Delay

### H MASTER CLEAN

## Programmes





Model: ADRA100; ADRA120

Programme	Load (kg)		Default Time (h:min)	
	10.0	12.0	10.0	12.0
Algodón/Algodão 	10.0	12.0	3:49	3:49
Sintéticos 	5.0	6.0	3:28	3:28
Mix 	10.0	12.0	1:30	1:30
20°C	5.0	6.0	1:11	1:11
Sport 	5.0	6.0	0:57	0:57
R. Bebé 	10.0	12.0	1:52	1:52
Jeans 	10.0	12.0	1:56	1:56
VapCare 	5.0	6.0	1:58	1:58
(Spin only) 	10.0	12.0	0:12	0:12
R. de cama 	10.0	12.0	1:48	1:48
Lana/Lã 	2.0	2.0	1:07	1:07
ECO 40-60 	10.0	12.0	3:59	4:00
Limp. tambor 	--	--	1:28	1:28
Express 15' 	2.0	2.0	0:15	0:15
Rápido 45' 	2.0	2.0	0:45	0:45

### NOTE





- The parameters in this table are only for user's reference. The actual parameters maybe different with the parameters in above mentioned table.

## Programmes

ADRA100							
Cycle	Nominal capacity in kg	Temperature setting °C	Cycle duration in hours and minutes	Energy consumption in kWh/operalling cycle	Water consumption in liter/operalling cycle	Highest temperature °C <sup>1)</sup>	Residual moisture in % / spin speed in rpm <sup>2)</sup>
Algodón/ Algodão 	10.0	60	3:54	1.726	85	60	53%/1400
Mix 	10.0	40	1:30	0.889	85	40	70%/800
20 °C	5.0	20	1:11	0.212	51	20	65%/1000
Express 15' 	2.0	Cold	0:15	0.030	31	Cold	70%/800
R. de cama 	10.0	40	1:48	0.920	85	40	65%/1000
ECO 40-60 <sup>3)</sup> 	10.0	--	3:59	0.895	67.0	41	53.9%/1350
	5.0	--	3:00	0.560	52.0	33	53.9%/1350
	2.5	--	3:00	0.232	41.5	23	53.9%/1350

- The above data is for reference only, and the data may change due to different actual use conditions.
- The values given for programmes other than the ECO 40-60 programme are indicative only.
- 20°C is able to clean lightly soiled cotton laundry, at a nominal temperature of 20°C, which complies with the regulation (EU) 2019/2023.
- Concerning to EN 60456:2016/prA2019 With (EU)2019/2014, (EU)2019/2023, (EU)2021/340,(EU)2021/341  
The EU energy efficiency class is: A  
Energy test program: ECO 40-60. Other as the default.  
Half load for 10.0kg machine: 5.0kg.  
Quarter load for 10.0kg machine: 2.5kg.

## Programmes

ADRA120							
Cycle	Nominal capacity in kg	Temperature setting °C	Cycle duration in hours and minutes	Energy consumption in kWh/operalling cycle	Water consumption in liter/operalling cycle	Highest temperature °C <sup>1)</sup>	Residual moisture in % / spin speed in rpm <sup>2)</sup>
Algodón/ Algodão 	12.0	60	3:54	1.936	99	60	53%/1400
Mix 	12.0	40	1:30	1.006	99	40	70%/800
20 °C	6.0	20	1:11	0.224	58	20	65%/1000
Express 15' 	2.0	Cold	0:15	0.030	31	Cold	70%/800
R. de cama 	12.0	40	1:48	1.037	99	40	65%/1000
ECO 40-60 <sup>3)</sup> 	12.0	--	4:00	1.186	82.0	42	53.9%/1350
	6.0	--	3:00	0.618	58.0	32	53.9%/1350
	4.0	--	3:00	0.254	46.0	24	53.9%/1350

- The above data is for reference only, and the data may change due to different actual use conditions.
- The valves given for programmes other than the ECO 40-60 programme are indicative only.
- 20°C is able to clean lightly soiled cotton laundry, at a nominal temperature of 20°C, which complies with the regulation (EU) 2019/2023.
- Concerning to EN 60456:2016/prA2019 With (EU)2019/2014, (EU)2019/2023, (EU)2021/340,(EU)2021/341  
The EU energy efficiency class is: A  
Energy test program: ECO 40-60. Other as the default.  
Half load for 10.0kg machine: 6.0kg.  
Quarter load for 10.0kg machine: 3.0kg.

## Programmes

- 1) The highest temperature reached by the laundry in the wash cycle for at least 5 minutes.
  - 2) Residual moisture after the wash cycle in water content percent and the spin speed at which this was achieved.
  - 3) The ECO 40-60 programme is able to clean normally soiled cotton laundry declared to be washable at 40°C or 60°C, together in the same cycle. This programme is used to assess the compliance with the regulation (EU) 2019/2023.
- The most efficient programmes in terms of energy consumption are generally those that perform at lower temperatures and longer duration.

Loading the household washing machine up to the capacity indicated for the respective programmes will contribute to energy and water savings.

Noise and remaining moisture content are influenced by the spinning speed: the higher the spinning speed in the spinning phase, the higher the noise and the lower the remaining moisture content.

















### CAUTION

- If there is any break in the power supply while the machine is operating, a special memory stores the selected programme. The machine will continue the programme when the power supply is re-established.

# OPERATION INSTRUCTIONS

Programmes are available according to the laundry type.























































Programmes	
Algodón/ Algodão 	Hard-wearing textiles, heat-resistant textiles made of cotton or linen.
Rápido 45' 	Washing few and not very dirty clothes quickly.
Sintéticos 	Washing synthetic articles, for example: shirts, coats, blending. While washing the knitting textiles, detergent quantity shall be reduced due to its loose string construction and easily forming bubbles.
R. bebé 	Washing the baby's clothes, it can make the baby's wear cleaner. and make the rinse performance better to protect the baby skin.
Jeans 	Specially for jeans.
Mix 	Mixed load consisting of textiles made of cotton and synthetics.
20°C	Able to clean lightly soiled cotton laundry, at a nominal temperature of 20 °C.
Sport 	Washing the activewear.
Express 15' 	Extra short programme approx, suitable for lightly soiled washing as a small amounts of laundry.
R. de cama 	This program is specially designed for washing Bulky.
Lana/Lã 	Hand or machine-washable wool or richwool textiles. Especially gentle wash programme to prevent shrinkage, longer programme pauses (textiles rest in wash liquor).
(Spin only) 	Spins and drains the water.
ECO 40-60 	Able to clean normally soiled cotton laundry declared to be washable at 40 °C or 60 °C, together in the same cycle.
VapCare 	Steam is applicable for daily laundries.
Limp. tambor 	Specially set in this machine to clean the drum and tube. It applies 90 °C high temperature sterilization to make the clothes washing more green. When this programme is performed, the clothes or other washing cannot be added. When proper amount of chlorine bleaching agent is put in, the barrel cleaning effect will be better. The customer can use this programme regularly according to the need.

## NOTE

- The Chart is reference only, please refer to real product as standard.
  - When the programme is finished, "End" will flash on the display, Please select the knob to the Off position.

# OPERATION INSTRUCTIONS

## Option

Cycle	Default Temp.(°C)	Default spin speed (rpm)	Additional functions
		1400	
Algodón/Algodão 	40	1400	   
Sintéticos 	40	1200	   
Mix 	40	800	   
20°C	20	1000	 
Sport 	20	800	  
R. Bebé 	60	1000	   
Jeans 	60	800	  
Limp. Tambor 	90	--	
(Spin only) 	--	1000	
R. de cama 	40	1000	   
Lana/Lã 	40	600	 
ECO 40-60 	--	1400	
VapCare 	40	1000	   
Express 15' 	Cold	800	
Rápido 45' 	20	800	 

## NOTE

- For the maximum spin speed, program time, and other details of the ECO 40-60 program, please refer to the content on the Product Fiche page.
- The table shows which cycle offers which options for adjustment. If an adjustment is not possible for a cycle.



### Centrifug.

When needed, the spinning speed can be adjusted pressing the Centrifug. button in the following steps: 1400:0-400-600-800-1000-1200-1400



### Início diferido/Início retardado (Delay)

1. Select a programme.
2. Press the Início diferido/Início retardado button to choose the delaying time 0-24H.
3. Press Início/Pausa to start the delay operation.



Choose programme



Setting time



Start

To cancel the Delay function, press the "Início diferido/Início retardado" button before starting the program until the display shows 0 H. If the program has already started, switch the appliance off and afterwards on and select a new programme.



### Pre Wash

Extra washing function before the main washing cycle starts to increase the washing performance.

Note: Detergent needs to be added to the compartment I.



### Extra Rinse

The laundry will undergo an extra rinse after selecting this function.



### Strong Wash

Very dirty clothes can choose it, select it can increase the washing time and intensity to increase the washing effect.



### MASTER CLEAN

When the MASTER CLEAN light is on, this function is automatically activated in the program. This drum cleaning function will be automatically activated during every washing cycle so it will keep your laundry always clean.



### Temp.

When needed, the washing temperature can be adjusted by pressing the temperature button in the following steps:  
Cold -20°C-30°C - 40°C- 60°C - 90°C.

## NOTE

### Usage counter

1. Unplug the equipment for 10s and reconnect again.
2. Power on and within 10s, please press "Centrifug." and "Función/Função" on control panel simultaneously and continuously for around 5s until the device display shows digits--the value can indicate the times of equipment usage.
3. Repeat step 1 again and customer can resume to normal operation.



# OPERATION INSTRUCTIONS

---



**Child Lock**  
To avoid mis-operation by children.



Press Inicio diferido/Início retardado and Función/Função simultaneously for 3 sec until the buzzer beep. The child lock indicator switches on.



## CAUTION

When the Child Lock is activated, the display will alternately show “CL” and the remaining time.

Pressing any other button will cause the Child Lock indicator to flash.

When the program ends, “CL” and “End” will alternate on the display.

The Child Lock deactivates the function of all buttons except the Child lock button!  
Only the simultaneous pressing of the two buttons Inicio diferido/Início retardado and Función/Função can deactivate the Child Lock!

Please deactivate the Child Lock before selecting a new program!

---



**Mute the buzzer**



Choose the Programme      Press the [Temp.] button for 3sec., the buzzer is mute.

To act the buzzer function, press the button again for 3 seconds.

The setting will be kept until the next reset.



## CAUTION

- After Muting the buzzer function, the sounds will not be activated any more.
- 



**Reload**

This operation can be executed during the washing progress. When the drum is still rolling and there is large amount of water with high temperature in the drum, the state is unsafe and the door cannot be opened forcefully. Press [▶▶] 3 sec. to reload, and start the clothes adding in the midway function. Please follow the steps as below:

1. Wait until the drum stops rotation.
2. The door lock is unlocked.
3. Close the door when the clothes are reloaded and press the Start/Pause button.



Press Start/Pause for 3 sec.

Reload the clothes

Start

---

# Product Fiche

Supplier's name or trade mark<sup>(\*)</sup>(<sup>(\*)</sup>): EAS ELECTRIC

Supplier's address<sup>(\*)</sup>(<sup>(\*)</sup>): P.I. San Carlos, Camino de la Sierra, S/N, Parcela 11 03370 Redován (Alicante) - ESPAÑA

Model identifier<sup>(\*)</sup>(<sup>(\*)</sup>): ADRA100

General product parameters:

Parameter	Value	Parameter	Value	
Rated capacity <sup>(b)</sup> (kg)	10.0	Dimensions in cm <sup>(c)</sup> ( <sup>(c)</sup> )	Height	85
			Width	60
			Depth	53
Energy efficiency index <sup>(a)</sup> (EEL )	51.9	Energy efficiency class <sup>(d)</sup>	A <sup>(d)</sup>	
Washing efficiency index <sup>(b)</sup>	1.031	Rinsing effectiveness (g/kg) <sup>(c)</sup>	5.0	
Energy consumption in kWh per cycle, based on the eco 40-60 programme at a combination of full and partial loads. Actual energy consumption will depend on how the appliance is used.	0.513	Water consumption in litre per cycle, based on the eco 40-60 programme at a combination of full and partial loads. Actual water consumption will depend on how the appliance is used and on the hardness of the water.s	52	
Maximum temperature inside the treat textile <sup>(c)</sup> (C )	Rated capacity	37	Weighted remaining moisture content <sup>(c)</sup> (%)	53.9
	Half	33		
	Quarter	23		
Spin speed <sup>(b)</sup> (rpm)	Rated capacity	1350	Spin-drying efficiency class <sup>(b)</sup>	B <sup>(d)</sup>
	Half	1350		
	Quarter	1350		
Programme duration <sup>(b)</sup> (h:min)	Rated capacity	3:59	Type	free-standing
	Half	3:00		
	Quarter	3:00		
Airborne acoustical noise emissions in the spinning phase <sup>(c)</sup> (dB(A) re 1 pW)	72	Airborne acoustical noise emission class <sup>(c)</sup> (spinning phase)	A <sup>(d)</sup>	
Off-mode (W) (if applicable)	0.50	Standby mode (W)(if applicable)	N/A	
Delay start (W) (if applicable)	4.00	Networked standby (W)(if applicable)	N/A	

Minimum duration of the guarantee offered by the supplier <sup>(\*)</sup>(<sup>(\*)</sup>): 3 years

This product has been designed to release silver ions during the washing cycle

NO

Additional information:

Weblink to the supplier's website, where the information in point 9 of Annex II to Commission Regulation (EU)2019/2023<sup>(1)</sup> is found: [www.ponjohnsonentuvida.es](http://www.ponjohnsonentuvida.es)

<sup>(\*)</sup> this item shall not be considered relevant for the purposes of Article 2(6) of Regulation (EU) 2017/1369,

<sup>(b)</sup> for the eco 40-60 programme.

<sup>(c)</sup> changes to this item shall not be considered relevant for the purposes of paragraph 4 of Article 4 of Regulation (EU)2017/1369.

<sup>(d)</sup> if the product database automatically generates the definitive content of this cell, the supplier shall not enter these data.

Supplier's name or trade mark<sup>(\*)</sup>(<sup>1</sup>): EAS ELECTRIC

Supplier's address<sup>(\*)</sup>(<sup>1</sup>): P.I. San Carlos, Camino de la Sierra, S/N, Parcela 11 03370 Redován (Alicante) - ESPAÑA

Model identifier<sup>(\*)</sup>(<sup>1</sup>): ADRA120

General product parameters:

Parameter	Value	Parameter	Value	
Rated capacity <sup>(b)</sup> (kg)	12.0	Dimensions in cm <sup>(c)</sup> ( <sup>1</sup> )	Height	85
			Width	60
			Depth	60
Energy efficiency index <sup>(a)</sup> (EEI )	52.0	Energy efficiency class <sup>(a)</sup>	A ( <sup>d</sup> )	
Washing efficiency index <sup>(a)</sup>	1.031	Rinsing effectiveness (g/kg) <sup>(a)</sup>	5.0	
Energy consumption in kWh per cycle, based on the eco 40-60 programme at a combination of full and partial loads. Actual energy consumption will depend on how the appliance is used.	0.544	Water consumption in litre per cycle, based on the eco 40-60 programme at a combination of full and partial loads. Actual water consumption will depend on how the appliance is used and on the hardness of the water.s	57	
Maximum temperature inside the treat textile <sup>(a)</sup> (C )	Rated capacity	42	Weighted remaining moisture content <sup>(a)</sup> (%)	53.9
	Half	32		
	Quarter	24		
Spin speed <sup>(b)</sup> (rpm)	Rated capacity	1350	Spin-drying efficiency class <sup>(a)</sup>	B ( <sup>d</sup> )
	Half	1350		
	Quarter	1350		
Programme duration <sup>(b)</sup> (h:min)	Rated capacity	4:00	Type	free-standing
	Half	3:00		
	Quarter	3:00		
Airborne acoustical noise emissions in the spinning phase <sup>(a)</sup> (dB(A) re 1 pW)	80.0	Airborne acoustical noise emission class <sup>(a)</sup> (spinning phase)	C ( <sup>d</sup> )	
Off-mode (W) (if applicable)	0.50	Standby mode (W)(if applicable)	1.00	
Delay start (W) (if applicable)	4.00	Networked standby (W)(if applicable)	N/A	

Minimum duration of the guarantee offered by the supplier <sup>(\*)</sup>(<sup>1</sup>): 3 years

This product has been designed to release silver ions during the washing cycle

NO

Additional information:

Weblink to the supplier's website, where the information in point 9 of Annex II to Commission Regulation (EU)2019/2023<sup>(1)</sup> is found: [www.ponjohnsonentuvida.es](http://www.ponjohnsonentuvida.es)

<sup>(\*)</sup> this item shall not be considered relevant for the purposes of Article 2(6) of Regulation (EU) 2017/1369,

<sup>(b)</sup> for the eco 40-60 programme.

<sup>(c)</sup> changes to this item shall not be considered relevant for the purposes of paragraph 4 of Article 4 of Regulation (EU)2017/1369.

<sup>(d)</sup> if the product database automatically generates the definitive content of this cell, the supplier shall not enter these data.

# CLEANING AND MAINTENANCE

## Cleaning and Care

### WARNING

- Always unplug the appliance and close the water tap before cleaning and maintenance.

### Cleaning the Cabinet

Proper maintenance on the machine can extend its working life. The surface can be cleaned with diluted non-abrasive neutral detergents when necessary. If there is any water overflow, use a towel to wipe it off immediately.

Never use sharp items to clean the appliance.

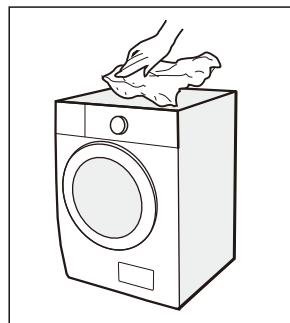

### CAUTION

- Never use abrasive or caustic agents. Such as formic acids or its diluted solvents or similar substances, like alcohol or chemical products.

### Cleaning the Drum

Any rust stains left inside the drum by metal articles must be removed immediately using chlorine-free detergents. Never use steel wool for cleaning the drum!

### NOTE

- Keep any laundry away from the machine while cleaning the drum.

### Cleaning the Door Seal and Glass

Wipe the glass and seal after each wash to remove lint and stains. If lint builds up it can cause leakages. Remove any coins, buttons and other objects from the seal after each wash. Clean the door seal and glass every month to ensure the normal operation of the appliance.

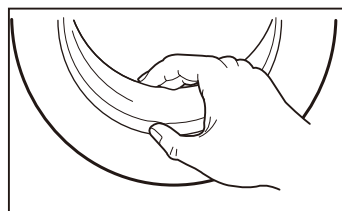

# CLEANING AND MAINTENANCE

## Cleaning the Inlet Filter

### NOTE

- Diminishing water flow is a sign that the filter needs to be cleaned.

1. Close the tap and remove the water supply hose from it.

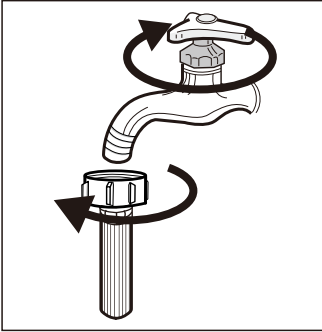

2. Clean the filter with a brush.

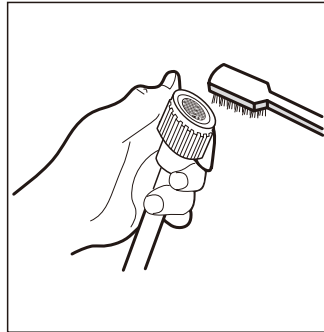

3. Unscrew the water supply hose from the backside of the machine. Pull out the filter with long nose pliers.

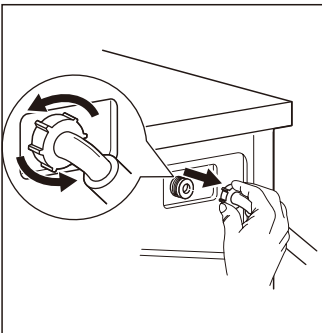

4. Use a brush to clean the

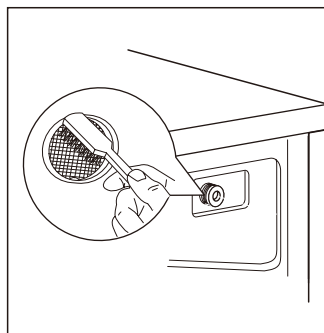

5. Reinstall the filter to the water inlet and reconnect the water supply hose.

6. Clean the Inlet filter every 3 months to ensure the normal operation of the appliance.

# CLEANING AND MAINTENANCE

## Cleaning the Detergent Dispenser

1. Press down the release [  ] on the softener cover and pull the dispenser drawer out of the recess. Clean the inside of the recess with a brush.
2. Lift the softener cover off the dispenser drawer and wash both items with water.
3. Restore the softener cover and push the drawer back into the recess.

1. Press the release and remove the dispenser drawer

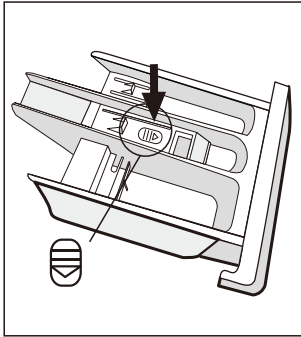

2. Clean the dispenser drawer and the softener cover under water

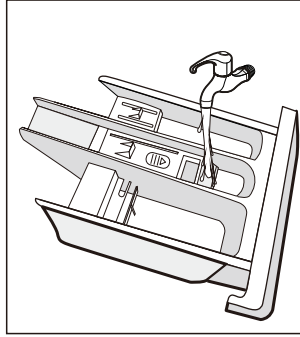

3. Clean the recess with a soft brush

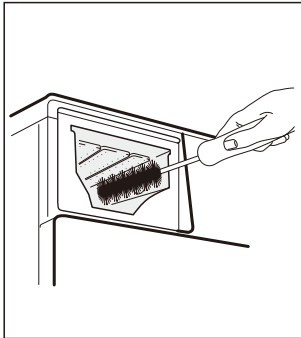

4. Insert the dispenser drawer

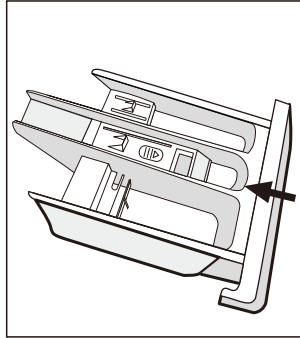

### NOTE

- Do not use abrasive or caustic agents to clean plastic parts.
- Clean the detergent dispenser every 3 months to ensure the normal operation of the appliance.

# CLEANING AND MAINTENANCE

## Cleaning the Drain Pump Filter

### WARNING

- Make sure that the machine has finished the washing cycle and is empty. Switch it off and unplug it before cleaning the drain pump filter.
- Be careful of hot water. Wait for water cooling down. Risk of scalding!
- Clean the filter periodically every 3 months to ensure the normal operation of the appliance.

1. Open the lower cover cap

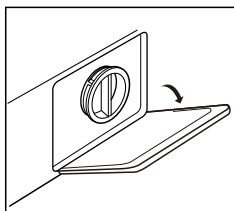

2. Open the filter by turning to the counter clockwise

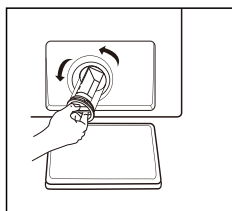

3. Remove extraneous matter

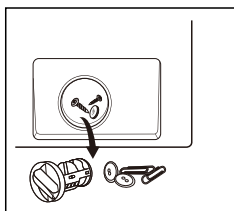

4. Close the lower cover cap

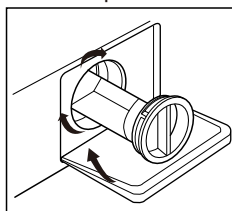

### CAUTION

- When the appliance is in use and depending on the programme selected there can be hot water in the pump. Never remove the pump cover during a wash cycle, always wait until the appliance has finished the cycle, and is empty. When replacing the cover, ensure it is securely re-tightened.

# TROUBLE SHOOTING

Whenever there is a problem with the appliance, check if you can solve it following the tables below. If the problem persists, please contact the customer service.

Description	Possible Cause	Solution
Appliance does not start	Door is not closed properly. Clothes are stuck.	Close the door properly and restart. Check the laundry.
Door can't be opened	Safety protection is activated.	Disconnect the power and restart.
Water leakage	Connections are not tight enough.	Check and fasten the water inlet pipe. Check and clean the outlet hose.
Detergent residues in the detergent dispenser	Detergent is damp and/or clotted.	Clean and wipe the detergent dispenser dry.
Indicator or display does not work	PC board or harness have connection problems.	Switch off the power and check if the mains plug is connected properly.
Abnormal noise	Fixing bolts are still in place. Floor is not solid or level.	Check if the fixing bolts have been removed. Make sure the appliance is installed on a solid and level floor.

## Error Codes

Description	Possible Cause	Solution
<b>E30</b>	Door is not closed properly.	Close the door properly and restart.
<b>E10</b>	Water injecting problem during wash cycle.	Check if the water pressure is high enough. Straighten the water pipe. Clean the inlet valve filter.
<b>E21</b>	Overtime water draining	Check the drain hose for blockage.
<b>E12</b>	Water overflow	Restart the appliance.
<b>EXX</b>	Others	Restart the appliance. If problem persists, please contact the customer service.



# DISPOSAL AND RECYCLING

 <p><b>DISPOSAL: Do not dispose this product as unsorted municipal waste. Collection of such waste separately for special treatment is necessary.</b></p>	<p>The european directive 2012/19 /UE on wasted electrical and electronic equipments (WEEE), requires that household electrical appliances must not be disposed of in the normal unsorted municipal waste stream. appliances must be collected separately in order to optimize the recovery and recycling of the materials they contain, and reduce the impact on human health and the environment.</p> <p>The crossed out “wheeled bin” symbol on the product reminds you of your obligation, that when you disposed of the appliances, it must be separately collected. Consumers should contact their local authority or retailer for information concerning the correct disposal of their old appliance.</p>
--	--

## Customer Service

Spare parts for your appliance are available for a minimum of 10 years following EU COMMISSION REGULATION 2019/2023 ANNEX II Ecodesign requirements.  
In case of questions, please contact our local customer service center.

### WARNING

Risk of electric shock

- Never try to repair an appliance which is defective or presumed to defective. You may put your own and future users' lives in danger. Only authorised specialists are allowed to carry out this repair work.
- Improper repair will void the warranty and subsequent damages can't be recognized!

## Transport

### IMPORTANT STEPS WHEN MOVING THE APPLIANCE

- Unplug the appliance and close the water inlet tap.
- Check if the door and the detergent dispenser are closed properly.
- Remove the water inlet pipe and the outlet hose from the house installations.
- Let the water drain completely from the appliance (see “Cleaning the Drain Pump Filter”)
- Important: Re-install the 4 transport bolts in the back of the appliance.
- This appliance is heavy. Transport with care. Never hold any protruding part of the machine when lifting. The machine door can not be used as a handle.

## WARRANTY CONDITIONS

This appliance is guaranteed for three years from the date of sale against all manufacturing defects, including labour and spare parts. In order to justify the date of purchase, it will be compulsory to present the invoice or purchase receipt. The conditions of this warranty apply only to Spain and Portugal. If you have purchased this product in another country, please consult your distributor for the applicable conditions.

## WARRANTY EXCLUSIONS

1. Remote controls, drain intake rubbers, dockings and door seals, weather stripping.
2. Damage to enamels, paints, nickel plating, chrome plating, oxidation or other types of aesthetic parts or components that do not affect the internal functioning of the appliance.
3. Damage to wear parts due to use, corrosion or oxidation, whether caused by normal use of the appliance or accelerated deterioration due to unfavorable environmental or climatic circumstances. Not suitable for outdoor use.
4. Damage to fragile pieces of glass, glass ceramic, plastics, handles, baskets, doors or light bulbs when their failure or breakage is not attributable to a manufacturing defect.
5. Faults produced by fortuitous causes or accidents of force majeure, or as a consequence of abnormal, negligent or inappropriate use of the device.
6. Civil liabilities of any nature.
7. Consequential damage to the appliance as long as it has not been caused by an internal malfunction.
8. Maintenance or upkeep of the appliance: periodic reviews, adjustments and greases.
9. Faults that accessories and complements, adapters, external cables, bags, spare parts of all kinds, lamps, as well as any part considered consumable by the manufacturer, may suffer.
10. Faults caused by incorrect or illegal installation, inadequate ventilation, lack of grounding in the home, power disturbances, inappropriate modifications or use of non-original spare parts.
11. Appliances used in industrial applications or for commercial purposes.
12. Appliances with illegible or altered serial number.
13. Defects or breakdowns produced as a result of fixes, repairs, modifications, or disassembly of the installation of the device by the user or by a technician not authorized by the manufacturer, or as a result of manifest non-compliance with the manufacturer's instructions for use and maintenance.
14. During the warranty period it is essential to keep all manuals together with the equipment. If the equipment is sold, donated or given away, the manual and all related documents must be given to the new user. If any of these are lost, their replacement cannot be claimed.
15. Faults that have their origin or are a direct or indirect consequence of: contact with liquids, chemicals and other substances, as well as conditions derived from the climate or the environment: earthquakes, fires, floods, excessive heat or any other external force, such as insects, rodents and other animals that may have access to the interior of the machine or its connection points.
16. Damages derived from terrorism, riot or popular tumult, legal or illegal demonstrations and strikes; facts of actions of the Armed Forces or the State Security Forces in times of peace; armed conflicts and acts of war (declared or not); nuclear reaction or radiation or radioactive contamination; vice or defect of the goods; facts classified by the Government of the Nation as "national catastrophe or calamity".

**Design and specifications are subject to change without notice for product improvement. Any changes to the manual will be updated on our website, you can check the latest version.**



[www.ponjohnsonentuvida.es](http://www.ponjohnsonentuvida.es)

# CONTENU

**FR**

- 3 PRÉCAUTIONS DE SÉCURITÉ**
  - 3 Précautions de sécurité
- 

- 7 SPÉCIFICATIONS**
  - 8 DESCRIPTION DU PRODUIT**
  - 9 DÉMARRAGE RAPIDE**
  - 12 INSTALLATION**
  - 16 FONCTIONNEMENT**
  - 31 NETTOYAGE ET MAINTENANCE**
- 

- 35 DÉPANNAGE**
- 36 ÉLIMINATION ET RECYCLAGE**
- 38 GARANTIE**

# PRÉCAUTIONS DE SÉCURITÉ

## Utilisation prévue

Ce produit est conçu pour un usage domestique et pour les textiles en quantités adaptées au lavage et au séchage en machine.

Cet appareil est destiné à une utilisation intérieure. N'utiliser que conformément à ces instructions. L'appareil n'est pas destiné à un usage commercial. Toute autre utilisation est considérée comme inappropriée et le fabricant n'est pas responsable de tout dommage ou blessure résultant d'une telle utilisation.

Cet appareil est destiné à être utilisé dans des environnements domestiques et similaires, tels que:

- Les cuisines du personnel dans les magasins, les bureaux et autres environnements de travail.
- Cottages.
- Pour les clients des hôtels, motels et autres environnements de type résidentiel;
- Environnements de chambres d'hôtes;
- Les espaces communs des appartements ou des laveries d'immeubles.

## Explication des symboles



### DANGER

Ce symbole indique qu'il existe des dangers pour la vie et la santé des personnes en raison de la présence de gaz extrêmement inflammable.



### AVERTISSEMENT DE TENSION ÉLECTRIQUE

Ce symbole indique qu'il existe un danger pour la vie et la santé des personnes en raison de la tension électrique.



### AVERTISSEMENT

Le mot de signalisation indique un danger avec un niveau de risque moyen qui, s'il n'est pas évité, peut entraîner la mort ou des blessures graves.



### ATTENTION

Le mot de signalisation indique un danger avec un faible degré de risque qui, s'il n'est pas évité, peut entraîner des blessures mineures ou modérées.



### REMARQUE

Le mot de signalisation indique une information importante (par exemple, des dégâts matériels), mais pas un danger.



### OBSERVER LES INSTRUCTIONS

Ce symbole indique qu'un technicien ne doit utiliser et entretenir cet appareil que conformément au mode d'emploi.

Veuillez lire attentivement les informations de sécurité suivantes et les respecter scrupuleusement afin de minimiser les risques d'incendie ou d'explosion, d'électrocution et d'éviter les dommages matériels, les blessures corporelles ou les pertes de vie. Le non-respect de ces instructions annule toute garantie.

Cet appareil n'est pas destiné à être utilisé par des personnes (y compris des enfants) dont les capacités physiques, sensorielles ou mentales sont réduites, ou qui manquent d'expérience et de connaissances, à moins qu'une personne responsable de leur sécurité ne les ait surveillées ou leur ait donné des instructions concernant l'utilisation de l'appareil.

## AVERTISSEMENT: Choc électrique

- Si le cordon d'alimentation est endommagé, il doit être remplacé par le fabricant, son agent de service ou des personnes de qualification similaire afin d'éviter tout danger.
- Si la machine est endommagée, elle ne doit pas être utilisée avant d'avoir été réparée par le fabricant, son agent de service ou des personnes de qualification similaire afin d'éviter tout risque de choc électrique.
- L'appareil peut être utilisé par des enfants à partir de 8 ans et par des personnes aux capacités physiques, sensorielles ou mentales réduites, ou manquant d'expérience et de connaissances, s'ils ont reçu une surveillance ou des instructions concernant l'utilisation de l'appareil en toute sécurité et s'ils comprennent les risques encourus. Les enfants ne doivent pas jouer avec l'appareil et ne doivent pas effectuer le nettoyage et l'entretien utilisateur sans surveillance.
- Les enfants doivent être surveillés pour s'assurer qu'ils ne jouent pas avec l'appareil.
- Les enfants de moins de 3 ans doivent être tenus à l'écart de l'appareil ou surveillés en permanence pour s'assurer qu'ils ne jouent pas avec l'appareil.
- Les animaux et les enfants peuvent entrer dans la machine. Vérifiez l'intérieur avant de mettre l'appareil en marche.
- Ne montez pas et ne vous asseyez pas sur l'appareil.

## Emplacement et environnement

- Conservez tous les détergents et produits de lavage dans un endroit sûr, hors de portée des enfants.
- N'installez pas la machine sur des tapis ou des moquettes. Si les ouvertures sont obstruées par le lave-linge, celui-ci risque de tomber en panne.
- Gardez l'appareil à l'écart des sources de chaleur et des rayons directs du soleil pour éviter la corrosion des pièces en plastique et en caoutchouc.
- N'utilisez pas l'appareil dans des environnements humides ou dans des pièces contenant des gaz explosifs ou caustiques. En cas de fuite d'eau ou d'éclaboussures affectant la machine, laissez-la sécher à l'air libre.
- L'appareil ne doit pas être installé derrière des portes verrouillables, des portes coulissantes ou des portes dont la charnière se trouve du côté opposé à celui du lave-linge.
- N'utilisez pas cette machine dans des pièces dont la température est inférieure à 5° C, car cela pourrait endommager certains de ses composants. Si cela est inévitable, veillez à vidanger complètement la machine après chaque utilisation (voir "Entretien - Nettoyage du filtre de la pompe de vidange") pour éviter les dommages causés par la glace.
- N'utilisez jamais de sprays ou de substances inflammables à proximité de l'appareil.

## Installation

- Retirez tous les emballages et les vis de transport avant d'utiliser l'appareil. Le non-respect de cette consigne peut entraîner de graves dommages.
- Cet appareil est équipé d'une valve à entrée unique et ne peut être raccordé qu'à l'alimentation en eau froide.
- La fiche doit rester accessible après l'installation.
- Avant de laver des vêtements pour la première fois, faites fonctionner l'appareil sur un cycle chaud sans vêtements à l'intérieur pour les nettoyer.
- Avant d'utiliser la machine, le produit doit être calibré.
- Ne placez pas d'objets lourds ou d'appareils de chauffage sur l'appareil.

# PRÉCAUTIONS DE SÉCURITÉ

- Utilisez les nouveaux tuyaux fournis avec l'appareil, ne réutilisez pas les anciens tuyaux.
- Pression maximale de l'eau à l'entrée: 1 MPa. Pression minimale d'entrée d'eau: 0,05 MPa.

## Connexion électrique

- Veillez à ce que le cordon d'alimentation ne soit pas coincé sous la machine, car cela pourrait l'endommager.
- Branchez le produit sur une prise de courant reliée à la terre et protégée par un fusible conforme aux valeurs nominales indiquées dans le tableau "Spécifications techniques". L'installation de la prise de terre doit être effectuée par un électricien qualifié. Assurez-vous que la machine est installée conformément aux réglementations locales.
- Les raccordements électriques et d'eau doivent être effectués par un technicien qualifié, conformément aux instructions du fabricant et aux règles de sécurité locales.

## AVERTISSEMENT:

- N'utilisez pas de barrettes d'alimentation, de multiprises ou de rallonges.
- L'appareil ne doit pas être équipé d'un dispositif de commutation externe tel qu'une minuterie, ni être connecté à un circuit qui est allumé et éteint fréquemment.
- Ne retirez pas la fiche de la prise en cas de présence de gaz inflammable.
- Ne débranchez jamais l'appareil avec des mains mouillées. Tirez toujours sur la fiche, pas sur le cordon. Débranchez l'appareil lorsqu'il n'est pas utilisé.

## Raccordements d'eau

- Vérifiez les connexions des tuyaux d'arrivée d'eau, du robinet d'eau et du tuyau d'évacuation pour détecter les problèmes dus aux changements de pression d'eau.
- Si les connexions sont lâches ou fuient, fermez le robinet d'arrêt et réparez-le. N'utilisez pas l'appareil avant d'avoir vérifié que les tuyaux et les raccords sont correctement installés par des techniciens qualifiés.
- La porte vitrée peut devenir très chaude pendant le fonctionnement. Tenez les enfants et les animaux domestiques à l'écart de la machine lorsqu'elle est en marche.
- Les tuyaux d'entrée et de sortie d'eau doivent être installés de manière sûre et ne doivent pas être endommagés, sous peine de provoquer des fuites d'eau. Ne retirez pas le filtre de la pompe de vidange tant qu'il reste de l'eau dans l'appareil. De grandes quantités d'eau chaude peuvent se déverser, ce qui peut provoquer des brûlures.

## Fonctionnement et maintenance

- N'utilisez jamais de solvants inflammables, explosifs ou toxiques. Les substances telles que l'essence, l'alcool, etc. ne doivent pas être utilisées comme détergents. Choisissez uniquement des détergents adaptés au lavage en machine.
- Assurez-vous que toutes les poches des vêtements sont vides. Les objets tranchants et rigides tels que les pièces de monnaie, les broches, les clous, les vis ou les pierres, ou les objets inflammables tels que les briquets et les allumettes peuvent endommager sérieusement la machine.
- Rincez soigneusement le linge lavé à la main.

- Les vêtements qui ont été souillés par des substances telles que l'huile de cuisson, l'acétone, l'alcool, l'essence, le kérosène, les détachants, la térébenthine, les cires et les décreurs doivent être lavés à l'eau chaude avec une quantité supplémentaire de détergent avant de les sécher dans l'appareil.
- Les articles tels que les tissus en caoutchouc mousse (mousse de latex), les bonnets de douche, les tissus imperméables, les articles à dos en caoutchouc et les vêtements ou oreillers en caoutchouc mousse ne doivent pas être séchés dans la machine.
- Les assouplisseurs de tissus ou produits similaires doivent être utilisés comme indiqué dans le mode d'emploi de l'assouplisseur.
- Ne forcez pas l'ouverture de la porte. Il se déverrouillera peu après la fin du cycle.
- Ne fermez pas la porte avec une force excessive. Si vous avez du mal à fermer la porte, vérifiez si le linge est bien réparti.
- Débranchez toujours l'appareil et fermez le robinet d'arrêt avant le nettoyage ou l'entretien et après chaque utilisation.
- Ne versez jamais d'eau sur l'appareil pour le nettoyer, car cela pourrait provoquer un choc électrique.
- Les réparations doivent être effectuées par le fabricant, son service après-vente ou d'autres professionnels qualifiés afin d'éviter tout risque. Le producteur n'est pas responsable des dommages causés par des personnes non autorisées.

## Transport

- Avant de le transporter:
  - Les vis de transport doivent être réinstallées par un professionnel qualifié.
  - L'eau accumulée doit être évacuée de la machine.
- Cet appareil est lourd, transportez-le avec précaution. Ne tenez jamais une partie saillante de la machine lorsque vous la soulevez. La porte de la machine ne peut pas être utilisée comme poignée.

Modèle	Capacité de lavage
ADRA100	10.0kg
ADRA120	12.0kg



# SPÉCIFICATIONS TECHNIQUES

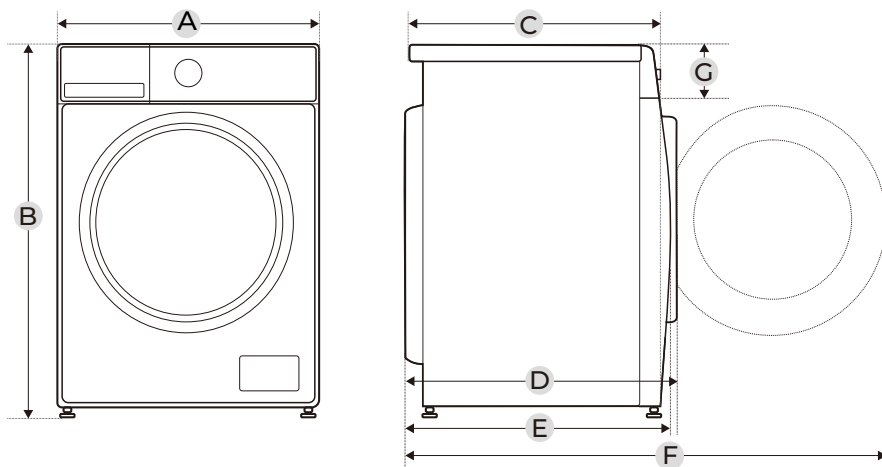

Modèle	ADRA100	ADRA120
Alimentation	220-240V~,50Hz	
Courant maximal	10A	
Pression d'eau standard	0.05MPa~1MPa	
Capacité de lavage	10.0kg	12.0kg
<b>Dimensions</b>		
A	595mm	595mm
B	850mm	850mm
C	530mm	595mm
Poids	65kg	73kg
Puissance nominale	2000W	2000W
<b>Dimensions de référence</b>		
D	600mm	660mm
E	540mm	641mm
F	1045mm	1105mm
G	135mm	135mm

# DESCRIPTION DU PRODUIT

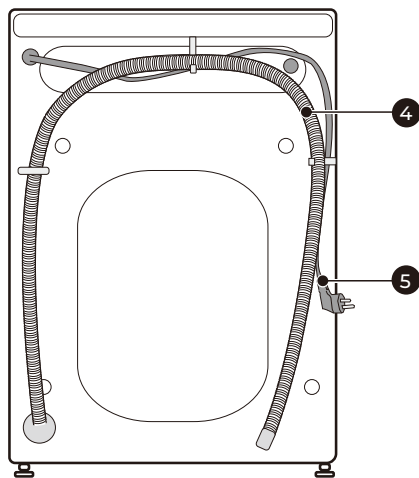
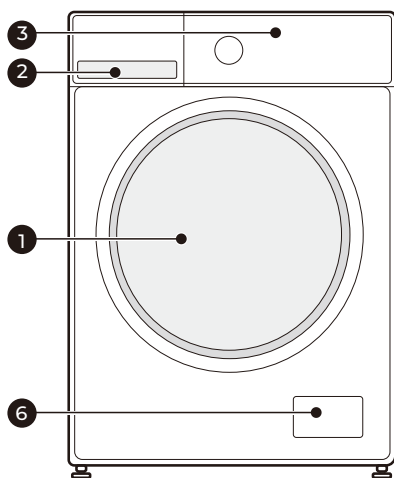

1	Porte	4	Tuyau de vidange
2	Distributeur de détergent	5	Cordon d'alimentation
3	Panneau de commande	6	Filtre de service

## REMARQUE

L'illustration n'est donnée qu'à titre de référence, il faut toujours se référer au produit réel comme norme.

## Accessoires

4 x bouchons

1 x Tuyau d'entrée  
de l'eau froide

1 x Manuel  
d'instructions

Éponges acoustiques  
(en option)

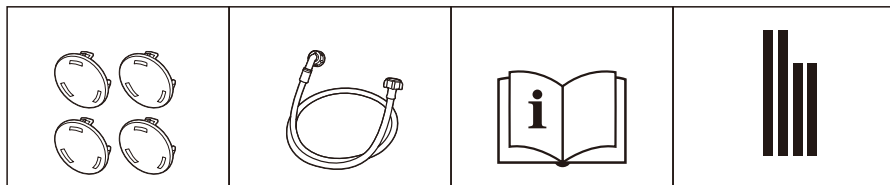

# DÉMARRAGE RAPIDE

## ATTENTION

- Avant de procéder au lavage, assurez-vous que l'appareil est correctement installé.
- L'appareil a été soigneusement contrôlé avant de quitter l'usine. Pour éliminer l'eau résiduelle et neutraliser les odeurs éventuelles, il est recommandé de nettoyer l'appareil avant la première utilisation. Pour cette raison, il est recommandé de nettoyer le tambour intérieur en exécutant le programme "Limp. tambor" ou un autre programme avec la température optionnelle de 90°C.

Veillez à ne pas mettre de linge et de détergent dans la machine.

## Calibrage

Il est recommandé de calibrer le lave-linge pour obtenir les meilleurs résultats. L'appareil peut détecter la quantité de charge insérée. Cette fonction optimise les performances du produit en minimisant la consommation d'énergie et d'eau, ce qui permet à l'utilisateur de gagner du temps et de l'argent. C'est pourquoi nous vous suggérons de le calibrer en suivant les étapes ci-dessous:

- 1- Retirez tous les accessoires du tambour et fermez la porte.
- 2- Branchez le lave-linge à la prise de courant.
- 3- Mettez la machine en marche et appuyez sur "Centrifug." pendant 10 secondes, jusqu'à ce que "t19" s'affiche.
- 4- Appuyez sur  pour démarrer l'appareil, "---" s'affiche d'abord, puis "\*\*\*\*" (par exemple "126") pour indiquer la vitesse du tambour en temps réel. Lorsque le nombre atteint une certaine valeur (cesse de changer), cela signifie que le lave-linge a été calibré avec succès.

## 1. Avant le lavage

### 1. Branchez

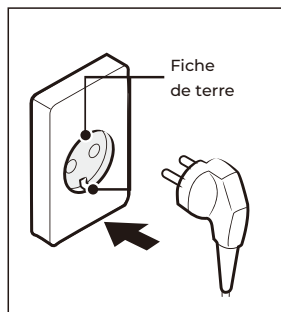

### 2. Ouvrez le robinet

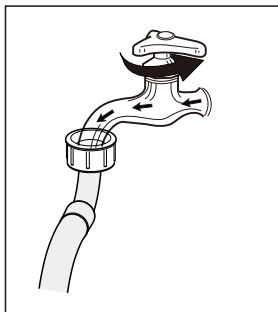

### 3. Chargez le linge

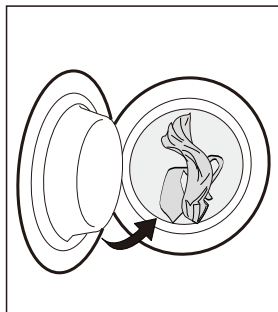

### 4. Fermez la porte

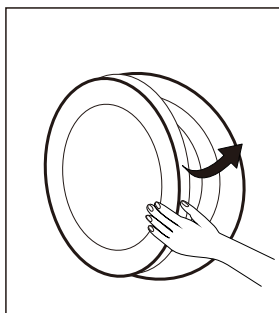

### 5. Ajoutez du détergent

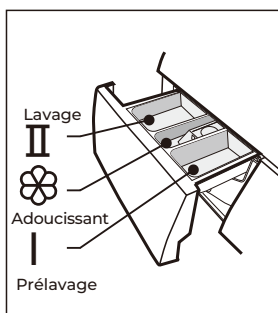

### ● REMARQUE

Vous devez ajouter le détergent dans la case I si vous sélectionnez le pré-lavage.

## 2. Lavage

1. Choisissez le programme

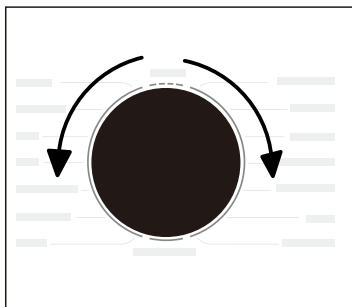

2. Sélectionnez la fonction / par défaut

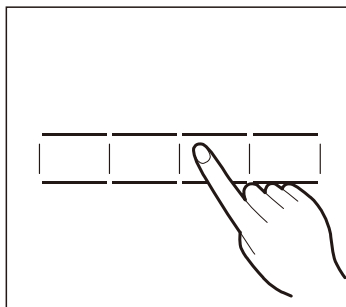

3. Appuyer sur Démarr./Pause pour démarrer le programme

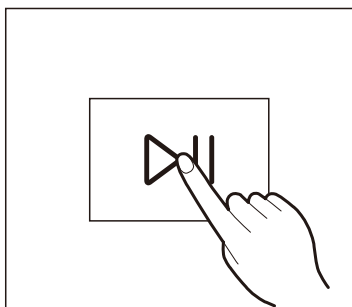

### ● REMARQUE

1: Si la valeur par défaut est sélectionnée, l'étape 2 peut être ignorée.

2: Le tableau des boutons de fonction n'est donné qu'à titre de référence, veuillez vous référer au produit réel.

## 3. Après le lavage

Le buzzer retentit et "End" apparaît sur l'écran.

# INSTALLATION

 Outils nécessaires pour une installation par vous-même (non inclus)

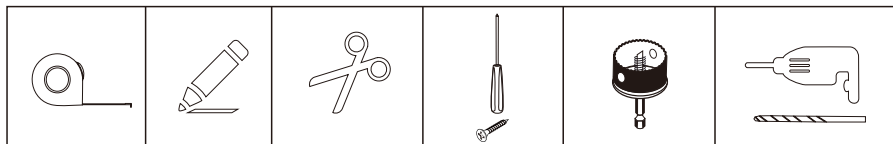

## Zone d'installation

### AVERTISSEMENT

- La stabilité est très importante pour empêcher le produit de bouger.
- Veillez à ce que la machine soit à niveau et stable.
- Assurez-vous que le produit ne repose pas sur le cordon d'alimentation.
- Veillez à respecter les distances minimales aux murs indiquées sur la photo.

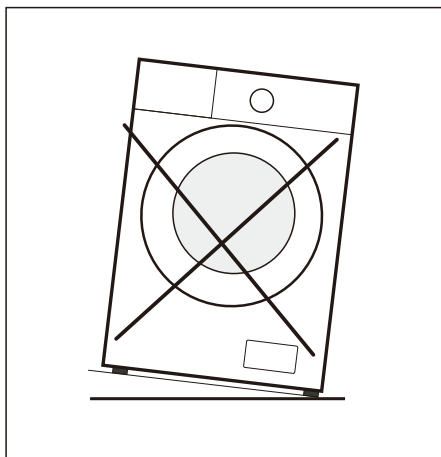
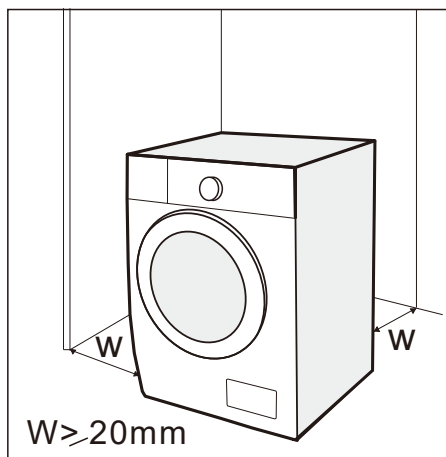

Avant d'installer la machine, il convient de choisir un emplacement répondant aux caractéristiques suivantes:

1. Une surface rigide, sèche et plane.
2. Pas de lumière solaire directe
3. Une ventilation suffisante
4. Température ambiante supérieure à 5°C
5. Loin des sources de chaleur telles que les cuisinières à charbon de bois ou à gaz.

## Déballage du lave-linge

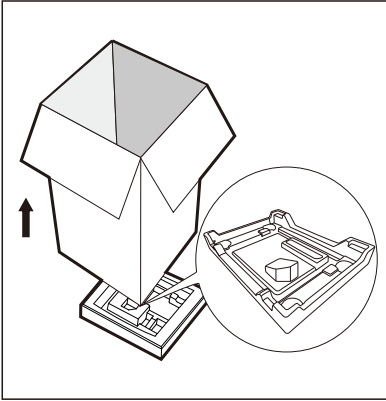

### ⚠ AVERTISSEMENT

Les matériaux d'emballage (comme le plastique et le polystyrène) peuvent être dangereux pour les enfants. Il y a un risque de suffocation. Conservez tous les emballages hors de portée des enfants.

1. Retirez la boîte en carton et l'emballage en polystyrène.
2. Soulevez l'appareil et retirez l'emballage de la base. Veillez également à retirer le petit bouchon triangulaire fixé à la base inférieure. S'il ne sort pas lorsque vous le tirez vers le haut, posez l'appareil sur le côté et retirez le bouchon inférieur à la main.
3. Retirez le ruban adhésif fixant le cordon d'alimentation et le tuyau de vidange.
4. Retirez le tuyau d'admission du tambour.

## Retirer les vis de transport

### ⚠ AVERTISSEMENT

Retirez les vis de transport à l'arrière avant d'utiliser le produit.

1. Desserrez les 4 vis de transport à l'aide d'une clé.

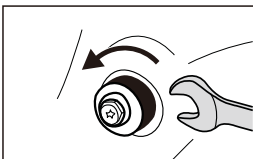

2. Retirez les vis et les rondelles en caoutchouc et conservez-les pour une utilisation ultérieure.

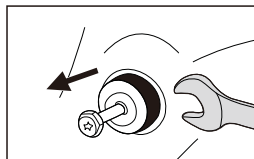

3. Fermez les trous avec les bouchons.

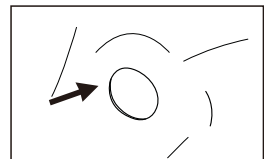

# INSTALLATION

## Équilibrer la lave-linge

### ⚠ AVERTISSEMENT

Les quatre écrous des pieds doivent être bien serrés.

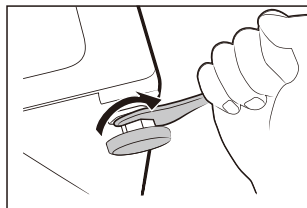

1. Desserrez le contre-écrou.
2. Faites pivoter la jambe jusqu'à ce qu'elle touche le sol.
3. Ajustez les pieds et bloquez les écrous à l'aide d'une clé. Vérifiez que la rondelle est équilibrée et stable.

## Raccorder le tuyau d'arrivée d'eau

### ⚠ AVERTISSEMENT

Pour éviter les fuites ou les dégâts d'eau, suivez les instructions ci-dessous.

- Ne pas plier, écraser, modifier ou couper la tuyauterie d'arrivée d'eau.

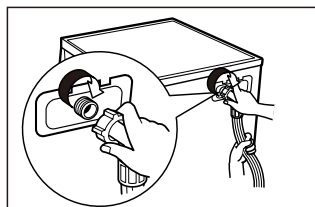

Connectez le tuyau d'alimentation en eau à la valve d'entrée d'eau et à un robinet d'eau froide comme indiqué.

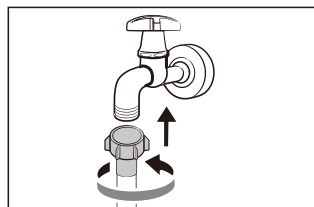

### ● REMARQUE

- Effectuez la connexion manuellement, sans outils. Vérifiez que les connexions sont bien serrées.

## Tuyau de drainage

### ⚠ AVERTISSEMENT

- Ne pas plier ou allonger le tuyau d'évacuation.
- Positionnez-le correctement ou une fuite d'eau peut se produire.



Il y a deux façons de raccorder l'extrémité du tuyau d'évacuation:

1. Vers l'égout principal

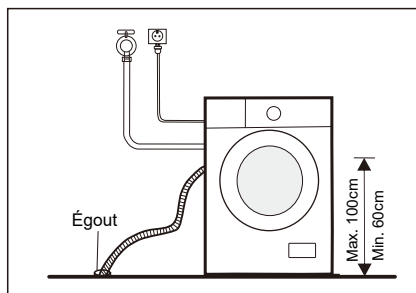

2. Raccordez-le à une branche de la canalisation principale.

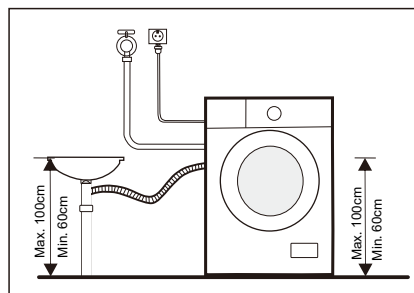

## Éponge acoustique

### REMARQUE

- Veillez à installer des éponges acoustiques, qui peuvent contribuer à réduire le bruit causé par la machine pendant son fonctionnement et assurer un environnement calme dans la maison.

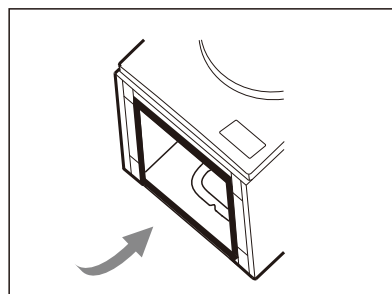
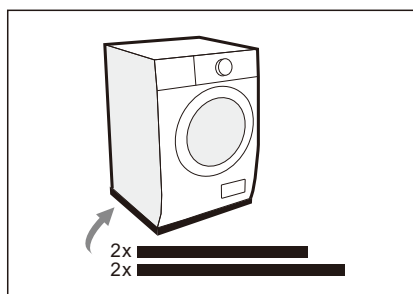

1. Posez l'appareil sur une surface matelassée pour le protéger.
2. Fixez les 2 bandes d'éponge les plus longues sur les côtés longs de l'unité, et les 2 bandes courtes sur les côtés plus étroits.

# FONCTIONNEMENT

## Avant chaque lavage

- La température ambiante de fonctionnement de l'appareil doit être comprise entre 5 et 40°C. En cas d'utilisation en dessous de 0°C, la valve d'entrée et le système de drainage peuvent être endommagés. Si l'appareil est installé dans des conditions très froides, il faut le passer à la température ambiante normale pour s'assurer que les tuyaux d'alimentation et d'évacuation de l'eau sont dégelés avant utilisation.
- Vérifiez les étiquettes et les instructions des détergents avant de les utiliser. Utilisez un détergent non moussant adapté au lavage en machine.

### 1. Sortez les objets des poches

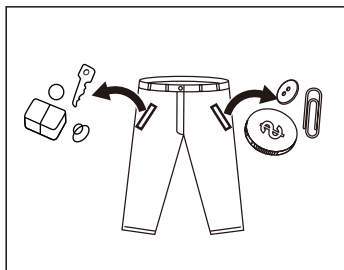

### 2. Séparez les vêtements de différentes couleurs et textures

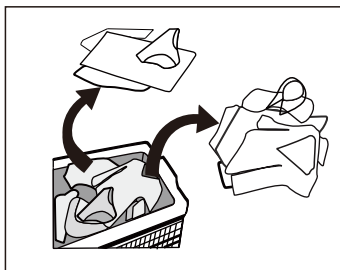

### 3. Nouez les rubans, fermez les fermetures éclair et attachez les boutons

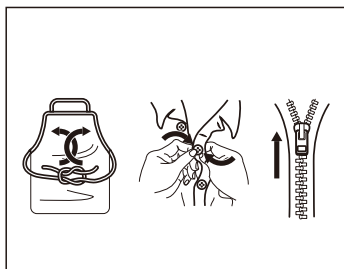

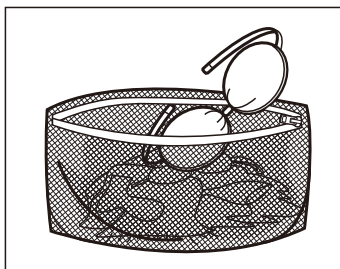

### 4. Mettez les petits articles dans des housses de lavage



## ⚠ AVERTISSEMENT

- Ne pas laver les articles qui ont été en contact avec du kérosène, de l'essence, de l'alcool, de la cire, de l'huile, de la peinture et d'autres substances inflammables.
- Le lavage d'un seul vêtement peut déséquilibrer la laveuse et déclencher une alerte. Il est conseillé d'ajouter un ou deux articles supplémentaires pour équilibrer le lavage et l'essorage.
- Ne lavez pas, n'essorez pas ou ne séchez pas les sièges, les tapis ou les vêtements imperméables.





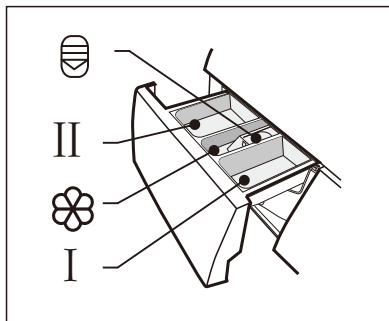













## Distributeur de détergent

- I Prélavage
- II Lavage principal
-  Adoucissant
-  Bouton pour retirer le distributeur



### ATTENTION







- Vous ne devez ajouter du détergent dans le compartiment "I" qu'après avoir sélectionné la fonction de prélavage.

Programme	I	II / 		Programme	I	II / 	
Algodón/Algodão 	<input type="radio"/>	<input checked="" type="radio"/>	<input type="radio"/>	(Essorage) 			
Sintéticos 	<input type="radio"/>	<input checked="" type="radio"/>	<input type="radio"/>	R. de cama 	<input type="radio"/>	<input checked="" type="radio"/>	<input type="radio"/>
Mix 	<input type="radio"/>	<input checked="" type="radio"/>	<input type="radio"/>	Lana/Lã 		<input checked="" type="radio"/>	<input type="radio"/>
Sport 	<input type="radio"/>	<input checked="" type="radio"/>	<input type="radio"/>	Express 15' 		<input checked="" type="radio"/>	<input type="radio"/>
R. Bébé 	<input type="radio"/>	<input checked="" type="radio"/>	<input type="radio"/>	Rápido 45' 		<input checked="" type="radio"/>	<input type="radio"/>
Jeans 	<input type="radio"/>	<input checked="" type="radio"/>	<input type="radio"/>	20°C		<input checked="" type="radio"/>	<input type="radio"/>
ECO 40-60 		<input checked="" type="radio"/>	<input type="radio"/>	VapCare 	<input type="radio"/>	<input checked="" type="radio"/>	<input type="radio"/>
Limp. tambor 							

- Nécessaire
- Optionnel

# FONCTIONNEMENT

## Recommandation de détergent

Recommandation de détergent	Type de textile	Cycles de lavage	Températ. lavage °C
Détergent à haute résistance avec des agents de blanchiment et d'éclaircissement optique.	Linge blanche en coton ou en lin résistant à l'ébullition	Algodón/Algodão  ECO 40-60 	40/60
Détergent coloré sans agent de blanchiment et azurants optiques	Vêtements colorés en coton ou en lin	Algodón/Algodão 	20/40
Détergent coloré ou doux sans azurants optiques	Vêtements colorés faits de fibres faciles à entretenir ou des synthétiques	Algodón/Algodão  Sintéticos 	20/40
Détergent doux pour le lavage	Textiles délicats, soie, viscose	Sintéticos 	20
Détergent spécial pour laine	Laine	Lana/Lã 	20/40

### REMARQUE

- Il est recommandé de diluer les détergents ou adoucissants plus épais avec de l'eau pour éviter que l'entrée de détergent ne soit obstruée et ne déborde lorsqu'elle est remplie d'eau.
- Choisissez un type de détergent approprié pour différentes températures de lavage et obtenez les meilleures performances avec moins de consommation d'eau et d'énergie.
- Pour obtenir les meilleurs résultats de lavage, il est important de doser le détergent. Utilisez une quantité réduite si le tambour n'est pas complètement plein.
- Ajustez toujours la quantité de détergent à la dureté de l'eau. Si elle est douce, utilisez moins de détergent.
- Dosez le détergent en fonction du niveau de saleté sur les vêtements.
- Un détergent à haute concentration (compact) nécessite un dosage particulièrement précis.

Les symptômes suivants sont le signe d'un excès de détergent:

- formation de beaucoup de mousse
- mauvais résultats de lavage et de rinçage

Les symptômes suivants sont le signe d'un manque de détergent:

- le linge devient gris
- accumulation de dépôts calcaires dans le tambour, dans l'appareil de chauffage ou dans le linge

## Panneau de commande

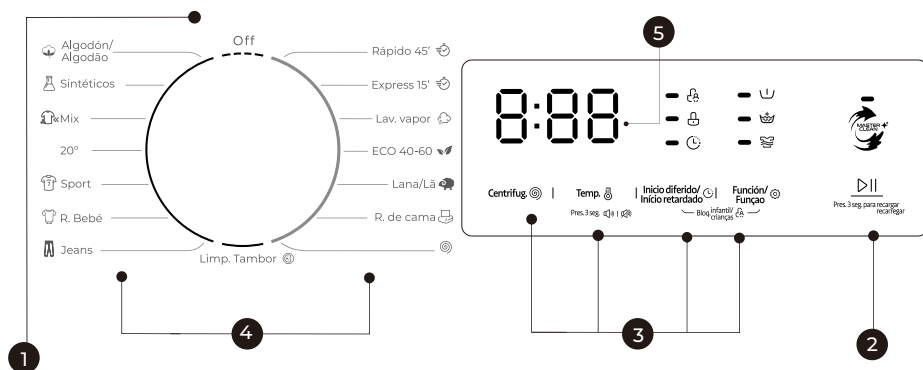

### 1 OFF

Éteindre l'appareil.

### 2 Démarr./Pause

Démarrer ou interrompre le programme

### 3 Options

Les fonctions supplémentaires s'allumeront une fois sélectionnées.

### 4 Programmes

Disponible selon le type de vêtements

### 5 Écran

L'écran affiche les réglages, le temps restant estimé, les options et les messages d'état.

## REMARQUE

- Le tableau n'est qu'une référence, veuillez vous référer au produit réel comme standard.

# FONCTIONNEMENT

## Display

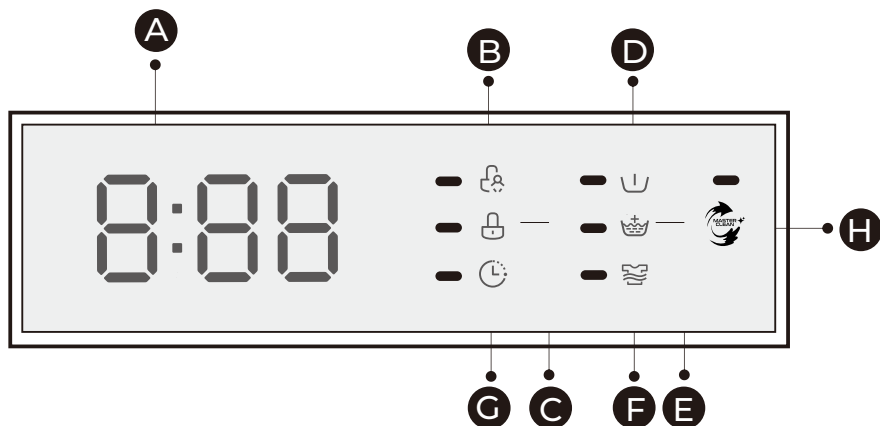

### **A** Display

Lavage  
125

Velocité  
400

End  
End

Retard

2H

Erreur

E30

Temp.

30

### **B** Verrouillage pour enfants

### **C** Verrou porte

### **D** Prélavage

### **E** Rinçage additionnel















### **F** Lavage intensif

### **G** Retard

### **H** MASTER CLEAN

## Programmes

Modèle: ADRA100; ADRA120

Programme	Charge (kg)		Durée affichée (h:min)	
	10.0	12.0	10.0	12.0
Algodón/Algodão 	10.0	12.0	3:49	3:49
Sintéticos 	5.0	6.0	3:28	3:28
Mix 	10.0	12.0	1:30	1:30
20°C	5.0	6.0	1:11	1:11
Sport 	5.0	6.0	0:57	0:57
R. Bebé 	10.0	12.0	1:52	1:52
Jeans 	10.0	12.0	1:56	1:56
VapCare 	5.0	6.0	1:58	1:58
(Essorage) 	10.0	12.0	0:12	0:12
R. de cama 	10.0	12.0	1:48	1:48
Lana/Lã 	2.0	2.0	1:07	1:07
ECO 40-60 	10.0	12.0	3:59	4:00
Limp. tambor 	--	--	1:28	1:28
Express 15' 	2.0	2.0	0:15	0:15
Rápido 45' 	2.0	2.0	0:45	0:45

### REMARQUE

- Les paramètres figurant dans ce tableau sont uniquement destinés à servir de référence à l'utilisateur. Les paramètres réels peuvent différer des paramètres indiqués dans le tableau ci-dessus.

## Programmes

### ADRA100

Cycle	Capacité nominale en kg	Réglage de la température °C	Durée du cycle en h: min	Consommation d'énergie en kWh/cycle	Consommation d'eau en litres / cycle	Température maximale (°C <sup>1)</sup> )	Humidité résiduelle en % / vitesse d'essorage en rpm <sup>2)</sup>
Algodón/ Algodão 	10.0	60	3:54	1.726	85	60	53%/1400
Mix 	10.0	40	1:30	0.889	85	40	70%/800
20 °C	5.0	20	1:11	0.212	51	20	65%/1000
Express 15' 	2.0	Froid	0:15	0.030	31	Froid	70%/800
R. de cama 	10.0	40	1:48	0.920	85	40	65%/1000
ECO 40-60 <sup>3)</sup> 	10.0	--	3:59	0.895	67.0	41	53.9%/1350
	5.0	--	3:00	0.560	52.0	33	53.9%/1350
	2.5	--	3:00	0.232	41.5	23	53.9%/1350

- Les données ci-dessus sont données à titre indicatif uniquement, elles peuvent varier en raison de changements dans les conditions réelles d'utilisation.
- Les valeurs des programmes autres que le programme ECO 40-60 sont uniquement indicatives.
- 20°C permet de nettoyer le linge en coton peu sale, à une température nominale de 20°C, ce qui est conforme au règlement (UE) 2019/2023.
- Selon la norme EN 60456:2016/prA2019 avec (EU)2019/2014, (EU)2019/2023, (EU)2021/340,(EU)2021/341 nouvelle classe d'efficacité énergétique de l'UE est: A
- Programme de test énergétique: ECO 40-60. Tous les autres: par défaut.
- Demi charge pour une machine de 10.0Kg: 5.0Kg. Quart de charge pour une machine de 10Kg: 2.5Kg.



## Programmes

### ADRA120

Cycle	Capacité nominale en kg	Réglage de la température °C	Durée du cycle en h: min	Consommation d'énergie en kWh/cycle	Consommation d'eau en litres / cycle	Température maximale °C <sup>1)</sup>	Humidité résiduelle en % / vitesse d'essorage en rpm <sup>2)</sup>
Algodón/ Algodão 	12.0	60	3:54	1.936	99	60	53%/1400
Mix 	12.0	40	1:30	1.006	99	40	70%/800
20 °C	6.0	20	1:11	0.224	58	20	65%/1000
Express 15' 	2.0	Froid	0:15	0.030	31	Froid	70%/800
R. de cama 	12.0	40	1:48	1.037	99	40	65%/1000
ECO 40-60 <sup>3)</sup> 	12.0	--	4:00	1.186	82.0	42	53.9%/1350
	6.0	--	3:00	0.618	58.0	32	53.9%/1350
	4.0	--	3:00	0.254	46.0	24	53.9%/1350

- Les données ci-dessus sont données à titre indicatif uniquement, elles peuvent varier en raison de changements dans les conditions réelles d'utilisation.
- Les valeurs des programmes autres que le programme ECO 40-60 sont uniquement indicatives.
- 20°C permet de nettoyer le linge en coton peu sale, à une température nominale de 20°C, ce qui est conforme au règlement (UE) 2019/2023.
- Selon la norme EN 60456:2016/prA2019 avec (EU)2019/2014, (EU)2019/2023, (EU)2021/340,(EU)2021/341 nouvelle classe d'efficacité énergétique de l'UE est: A
- Programme de test énergétique: ECO 40-60. Tous les autres: par défaut.
- Demi charge pour une machine de 12.0Kg: 6.0Kg. Quart de charge pour une machine de 12Kg: 3.0Kg.

## Programmes

- 1) La température la plus élevée atteinte par le linge au cours du cycle de lavage pendant au moins 5 minutes.
- 2) L'humidité résiduelle après le cycle de lavage en pourcentage de teneur en eau et la vitesse d'essorage à laquelle elle a été atteinte.
- 3) Le programme ECO 40-60 permet de nettoyer le linge de coton normalement sale déclaré lavable à 40°C ou 60°C, dans le même cycle. Ce programme est utilisé pour évaluer la conformité au règlement (UE) 2019/2023.

Les programmes les plus efficaces en termes de consommation d'énergie sont généralement ceux qui fonctionnent à des températures plus basses et pendant plus longtemps.

Le fait de charger le lave-linge ménager jusqu'à la capacité indiquée pour les programmes respectifs contribue à économiser l'énergie et l'eau.

Le bruit et la teneur en eau résiduelle sont influencés par la vitesse d'essorage: plus la vitesse d'essorage est élevée pendant la phase d'essorage, plus le bruit est important et plus la teneur en eau résiduelle est faible.

















### **ATTENTION**

- En cas de coupure de courant pendant que la machine est en marche, une mémoire spéciale est démarrée qui mémorise le programme sélectionné. La machine continuera avec le même programme lorsqu'elle sera rétablie.

# FONCTIONNEMENT

Des programmes sont disponibles en fonction du type de linge.















Programmes	
Algodón/ Algodão 	Tissus résistants à la chaleur, en coton ou en lin.
Rápido 45' 	Laver rapidement le linge peu ou pas sale.
Sintéticos 	Lavage d'articles synthétiques, par exemple: chemises, manteaux, mélanges. Lors du lavage des textiles à tricoter, la quantité de détergent doit être réduite en raison de la structure lâche des fils et de la formation facile de bulles.
R. bébé 	Pour le lavage des vêtements de bébé, vous pouvez les nettoyer plus en profondeur et rendre le rinçage plus efficace pour protéger la peau du bébé.
Jeans 	Spécialement pour les jeans.
Mix 	Chargement mixte composé de textiles en coton et en matières synthétiques.
20°C	Capable de nettoyer du linge en coton peu sale, à une température nominale de 20 °C.
Sport 	Lavage des vêtements de sport.
Express 15' 	Programme extra court, adapté au linge peu chargé et peu sale.
R. de cama 	Spécialement conçu pour le lavage des vêtements volumineux
Lana/Lã 	Textiles en laine ou en laine noble lavables à la main ou en machine. Programme de lavage particulièrement doux pour éviter le rétrécissement, pauses de programme plus longues (les textiles reposent dans la solution de lavage).
(Essorage) 	Essore et draine l'eau.
ECO 40-60 	Capable de nettoyer du linge en coton normalement sale déclaré lavable à 40 °C ou 60 °C, ensemble dans le même cycle.
VapCare 	La vapeur s'applique aux blanchisseries quotidiennes.
Limp. tambor 	Ce programme est conçu pour nettoyer le tambour et le tube. Il applique une stérilisation à haute température de 90°C pour rendre le lavage du linge plus écologique. Lors de l'exécution de ce programme, il est impossible d'ajouter du linge ou d'autres produits de lavage. Lorsque la bonne quantité d'agent de blanchiment au chlore est ajoutée, l'effet de nettoyage du tambour sera meilleur. Le client peut utiliser ce programme régulièrement en fonction de ses besoins.

## NOTE

- Le tableau n'est qu'une référence, veuillez vous référer au produit réel.
- Lorsque le programme est terminé, le mot "End" clignote sur l'écran, et il faut mettre le bouton en position "Off".

# FONCTIONNEMENT

## Options

Cycle	Température par défaut (°C)	Vitesse d'essorage par défaut en (rpm)	Fonctions supplémentaires
		1400	
Algodón/Algodão 	40	1400	🕒, 📏, 🏠, 🌀
Sintéticos 	40	1200	🕒, 📏, 🏠, 🌀
Mix 	40	800	🕒, 📏, 🏠, 🌀
20°C	20	1000	🕒, 🏠
Sport 	20	800	🕒, 📏, 🏠
R. Bebé 	60	1000	🕒, 📏, 🏠, 🌀
Jeans 	60	800	🕒, 📏, 🏠
Limp. Tambor 	90	--	🕒
(Essorage) 	--	1000	🕒
R. de cama 	40	1000	🕒, 📏, 🏠, 🌀
Lana/Lã 	40	600	🕒, 🏠
ECO 40-60 	--	1400	🕒
VapCare 	40	1000	🕒, 📏, 🏠, 🌀
Express 15' 	Cold	800	🕒
Rápido 45' 	20	800	🕒, 🏠

## REMARQUE

- Consultez la vitesse d'essorage maximale, la durée et les autres détails du programme ECO 40-60 dans la fiche produit.
- Le tableau indique les options offertes par chaque cycle, et si un réglage n'est pas disponible pour un programme.



### Vitesse d'essorage

Si nécessaire, vous pouvez régler la vitesse d'essorage en appuyant sur le bouton Centrifug. dans l'ordre suivant: 1400:0-400-600-800-1000-1200-1400



### Inicio diferido/Início retardado (Démarrage retardé)

1. Sélectionner un programme.
2. Appuyez sur le bouton Inicio diferido/Início retardado pour choisir le temps de retard 0-24H.
3. Appuyer sur [Démarrer/Pause] pour lancer l'opération de retardement.



Sélectionner un programme. Temps de réglage Démarrer

Pour annuler la fonction Inicio diferido/Início retardado appuyez sur la touche "Inicio diferido/Início retardado" avant de commencer le programme jusqu'à ce que l'écran affiche 0 H. Si le programme a déjà commencé, éteignez l'appareil, puis rallumez-le et sélectionnez un nouveau programme.



### Pré lavage

Fonction de lavage supplémentaire avant le début du cycle de lavage principal pour augmenter les performances de lavage.

Remarque : le détergent doit être ajouté dans le compartiment I.



### Rinçage additionnel

Le linge subira un rinçage supplémentaire après avoir sélectionné cette fonction.



### Lavage intensif

Sélectionnez cette fonction pour le linge très sale, vous pouvez augmenter la durée et l'intensité du lavage pour accroître le degré de propreté.



### MASTER CLEAN

Lorsque le voyant MASTER CLEAN est allumé, cette fonction est activée automatiquement dans le programme. La fonction est automatiquement activée à chaque cycle de lavage. Le système MASTER CLEAN permet de garder votre linge toujours propre.



### Température

Si nécessaire, la température de lavage peut être réglée en appuyant sur la touche de température dans les étapes suivantes :  
Froide -20°C-30°C - 40°C- 60°C - 90°C.

## REMARQUE

### Compteur d'usage

1. Débrancher l'appareil pendant 10 secondes et le rebrancher.
2. Mettez l'appareil sous tension et, dans les 10 secondes qui suivent, appuyez simultanément et continuellement sur les touches "Centrifug." et "Función/ Função" du panneau de commande pendant environ 5 secondes jusqu'à ce que l'écran de l'appareil affiche des chiffres -- la valeur peut indiquer les heures d'utilisation de l'appareil.
3. Répétez l'étape 1 à nouveau et le client peut reprendre son fonctionnement normal.

# FONCTIONNEMENT



## Verrouillage pour enfants

Cette fonction empêche les enfants de mal utiliser les commandes.



Appuyez sur les boutons Inicio diferido/Início retardado et Función/Função pendant 3 secondes jusqu'à ce que l'alarme retentisse, ce qui indique que la sécurité enfant est activé

## ATTENTION

Lorsque la sécurité enfant est activée, l'écran affiche alternativement "CL" et le temps restant.

Lorsque vous appuyez sur n'importe quelle autre touche, le témoin de la sécurité enfants clignote.

Après la fin du programme, "CL" et "END" s'affichent alternativement à l'écran. Le Bloqueo infantil verrouille toutes les touches, à l'exception du Bloqueo infantil. Appuyez sur les boutons Inicio diferido/Início retardado et Function/Função pour désactiver la sécurité enfants. Désactivez la sécurité enfants avant de sélectionner un nouveau programme.



## Désactiver les alertes



Choisir un programme



Appuyez sur le bouton Temp. pendant 3 secondes et les bips seront coupés.

Pour activer le bip sonore, appuyez à nouveau sur le bouton pendant 3 secondes. Le réglage est conservé jusqu'à ce que vous le modifiez à nouveau.

## ATTENTION

- Après avoir désactivé la fonction buzzer, les alertes cessent de retentir.



## Recharger

Cette opération peut être exécutée pendant le processus de lavage. Lorsque le tambour est encore en rotation et avec une grande quantité d'eau à température élevée, l'état est dangereux et la porte ne doit pas être ouverte avec force. Appuyez sur ▷|| pendant 3 secondes pour recharger et introduire le linge. Suivez les instructions ci-dessous :

1. Attendez que le tambour s'arrête de tourner.
2. Ouvrez la porte.
3. Fermez la porte après avoir inséré le linge et appuyez sur le bouton ▷||.



Appuyez ▷|| pendant 3s.



Insérer les vêtements



Démarrer

# Fiche du produit

Nom du distributeur<sup>(a),(c)</sup>: EAS ELECTRIC

Direction<sup>(a),(c)</sup>: P.I. San Carlos, Camino de la Sierra, S/N, Parcela 11 03370 Redován (Alicante) - ESPAÑA

Modèle<sup>(a)</sup>: ADRA100

Paramètres généraux du produit:

Paramètre	Valeur		Paramètre	Valeur	
Capacité nominale <sup>(b)</sup> (kg)	10.0		Dimensions en cm <sup>(b),(c)</sup>	Haut	85
				Largeur	60
				Fonds	53
Indice d'efficacité énergétique <sup>(b)</sup> (EEI <sub>w</sub> )	51.9		Classe d'efficacité énergétique <sup>(*)</sup>	A <sup>(d)</sup>	
Indice d'efficacité de lavage <sup>(b)</sup>	1.031		Efficacité du rinçage (g/kg) <sup>(b)</sup>	5.0	
Consommation d'énergie en kWh par cycle pour un cycle de lavage du lave-linge avec le programme ECO 40-60 en combinaison de charges complètes et partielles. La consommation d'énergie réelle dépendra de la façon dont l'appareil est utilisé.	0.513		Consommation d'eau en litres par cycle pour un cycle de lavage du lave-linge avec le programme ECO 40-60 en combinaison de charges complètes et partielles. La consommation réelle de l'eau dépendra de la manière dont l'appareil est utilisé et de la dureté de l'eau.	52	
Température maximale à l'intérieur du textile traité <sup>(b)</sup> (°C)	Capacité nominale	37	Teneur en humidité résiduelle pondérée <sup>(b)</sup> (%)	53.9	
	Demi	33			
	Quart	23			
Vitesse d'essorage <sup>(b)</sup> (rpm)	Capacité nominale	1350	Classe d'efficacité d'essorage <sup>(b)</sup>	B <sup>(d)</sup>	
	Demi	1350			
	Quart	1350			
Durée du programme <sup>(b)</sup> (h:min)	Capacité nominale	3:59	Type	Indépendant	
	Demi	3:00			
	Quart	3:00			
Émissions acoustiques aériennes pendant la phase d'essorage <sup>(b)</sup> (dB(A) re 1 pW)	72		Classe des émissions acoustiques aériennes pendant la phase d'essorage <sup>(b)</sup> (dB(A) re 1 pW)	A <sup>(d)</sup>	
Mode arrêt (W) le cas échéant	0.50		Mode veille (W) le cas échéant	N/A	
Démarrage différé (W) le cas échéant	4.00		Veille en réseau (W) le cas échéant	N/A	

Durée minimale de la garantie offerte par le fournisseur<sup>(a),(c)</sup>: 3 ans

Cet appareil a été conçu pour libérer des ions pendant le cycle de lavage:

NON

Information complémentaire

Web sur lequel vous pouvez trouver les informations du point 9 de l'annexe II de la norme UE 2019/2023<sup>(†)</sup>: [www.ponjohnsonentuvida.es](http://www.ponjohnsonentuvida.es)

<sup>(†)</sup> Ces données ne sont pas considérées comme pertinentes aux fins de l'article 2, paragraphe 6, de l'UE 2017/1369.

<sup>(b)</sup> Pour le programme ECO 40-60

<sup>(c)</sup> Les modifications apportées à ces éléments ne doivent pas être considérées comme pertinentes aux fins de l'article 4, paragraphe 4, de l'UE 2017/1369.

<sup>(d)</sup> Si la base de données génère automatiquement un contenu définitif dans cette cellule, le fournisseur ne doit pas saisir cette donnée.

## Fiche du produit

Nom du distributeur<sup>(a),(c)</sup>: EAS ELECTRIC

Direction<sup>(a),(c)</sup>: P.I. San Carlos, Camino de la Sierra, S/N, Parcela 11 03370 Redován (Alicante) - ESPAÑA

Modèle<sup>(a)</sup>: ADRA120

Paramètres généraux du produit:

Paramètre	Valeur		Paramètre	Valeur	
Capacité nominale <sup>(b)</sup> (kg)	12.0		Dimensions en cm <sup>(b),(c)</sup>	Haut	85
				Largeur	60
				Fonds	60
Indice d'efficacité énergétique <sup>(b)</sup> (EEI <sub>w</sub> )	52.0		Classe d'efficacité énergétique <sup>(*)</sup>	A <sup>(d)</sup>	
Indice d'efficacité de lavage <sup>(b)</sup>	1.031		Effacité du rinçage (g/kg) <sup>(b)</sup>	5.0	
Consommation d'énergie en kWh par cycle pour un cycle de lavage du lave-linge avec le programme ECO 40-60 en combinaison de charges complètes et partielles. La consommation d'énergie réelle dépendra de la façon dont l'appareil est utilisé.	0.544		Consommation d'eau en litres par cycle pour un cycle de lavage du lave-linge avec le programme ECO 40-60 en combinaison de charges complètes et partielles. La consommation réelle de l'eau dépendra de la manière dont l'appareil est utilisé et de la dureté de l'eau.	57	
Température maximale à l'intérieur du textile traité <sup>(b)</sup> (°C)	Capacité nominale	42	Teneur en humidité résiduelle pondérée <sup>(b)</sup> (%)	53.9	
	Demi	32			
	Quart	24			
Vitesse d'essorage <sup>(b)</sup> (rpm)	Capacité nominale	1350	Classe d'efficacité d'essorage <sup>(b)</sup>	B <sup>(d)</sup>	
	Demi	1350			
	Quart	1350			
Durée du programme <sup>(b)</sup> (h:min)	Capacité nominale	4:00	Type	Indépendant	
	Demi	3:00			
	Quart	3:00			
Émissions acoustiques aériennes pendant la phase d'essorage <sup>(b)</sup> (dB(A) re 1 pW)	80.0		Classe des émissions acoustiques aériennes pendant la phase d'essorage <sup>(b)</sup> (dB(A) re 1 pW)	C <sup>(*)</sup>	
Mode arrêt (W) le cas échéant	0.50		Mode veille (W) le cas échéant	1.00	
Démarrage différé (W) le cas échéant	4.00		Veille en réseau (W) le cas échéant	N/A	

Durée minimale de la garantie offerte par le fournisseur<sup>(a),(c)</sup>: 3 ans

Cet appareil a été conçu pour libérer des ions pendant le cycle de lavage:

NON

Information complémentaire

Web sur lequel vous pouvez trouver les informations du point 9 de l'annexe II de la norme UE 2019/2023<sup>(\*)</sup>: [www.ponjohnsonentuvida.es](http://www.ponjohnsonentuvida.es)

<sup>(\*)</sup> Ces données ne sont pas considérées comme pertinentes aux fins de l'article 2, paragraphe 6, de l'UE 2017/1369.

<sup>(b)</sup> Pour le programme ECO 40-60

<sup>(c)</sup> Les modifications apportées à ces éléments ne doivent pas être considérées comme pertinentes aux fins de l'article 4, paragraphe 4, de l'UE 2017/1369.

<sup>(d)</sup> Si la base de données génère automatiquement un contenu définitif dans cette cellule, le fournisseur ne doit pas saisir cette donnée.



# NETTOYAGE ET MAINTENANCE

## Nettoyage et entretien

### AVERTISSEMENT

- Avant de commencer l'entretien, débranchez la machine et coupez l'eau.

### Nettoyage le couvercle du lave-linge

Un entretien approprié de la machine peut prolonger sa durée de vie. La surface peut être nettoyée avec des détergents neutres et non abrasifs si nécessaire. S'il y a un débordement d'eau, utilisez un chiffon pour l'essuyer immédiatement.

N'utilisez jamais d'objets pointus pour nettoyer l'appareil.

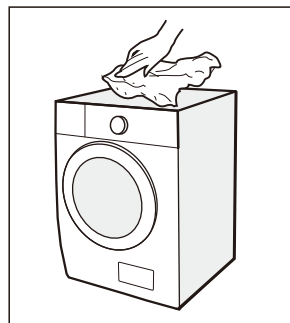

### ATTENTION

- N'utilisez pas d'acide formique ou de solvants dilués ou équivalents tels que de l'alcool ou d'autres produits chimiques.

### Nettoyage du tambour intérieur

Any rust stains left inside the drum by metal articles must be removed immediately using chlorine-free detergents. Never use steel wool for cleaning the drum!

### REMARQUE

- Ne mettez pas de linge dans la machine pendant le nettoyage du tambour.

### Nettoyage du joint de la porte et du verre

Nettoyez le verre et le joint après chaque lavage pour éliminer les peluches et les taches. Si les peluches s'accumulent, elles peuvent provoquer des fuites. Retirez les pièces de monnaie, les boutons ou autres objets après chaque lavage. Nettoyez la vitre et le joint une fois par mois pour assurer le bon fonctionnement de l'appareil.

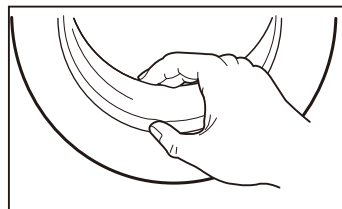

# NETTOYAGE ET MAINTENANCE

## Nettoyage du filtre d'entrée d'eau

### REMARQUE

- Si une quantité moindre d'eau entre, le filtre d'entrée doit être nettoyé.

1. Fermez le robinet d'arrêt et retirez le tuyau d'admission.

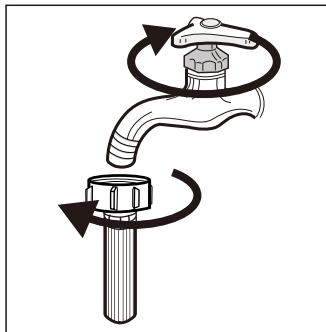

2. Nettoyez le filtre avec une brosse.

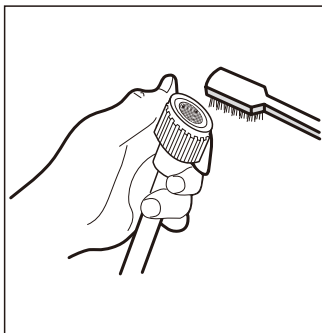

3. Dévissez le tuyau d'alimentation en eau à l'arrière du lave-linge. Retirez le filtre avec des pinces longues.

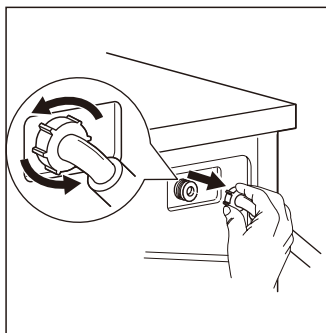

4. Nettoyez le filtre avec une brosse.

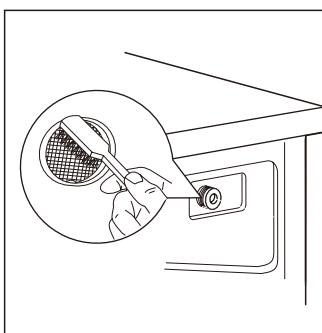

5. Remplacez le filtre et le tuyau d'alimentation en eau.

6. Nettoyez le filtre d'entrée tous les 3 mois pour assurer un fonctionnement normal.

# NETTOYAGE ET MAINTENANCE

## Nettoyage du tiroir à détergent

1. Appuyez sur le verrou  du couvercle de l'adoucisseur et retirez la boîte du distributeur. Nettoyez l'intérieur avec une brosse.
2. Retirez le couvercle de l'adoucisseur et la boîte du distributeur et nettoyez-les tous les deux à l'eau.
3. Remplacez le couvercle de l'adoucisseur et la boîte du distributeur dans leurs logements respectifs.

1. Appuyez sur le verrou et retirez la boîte du distributeur.

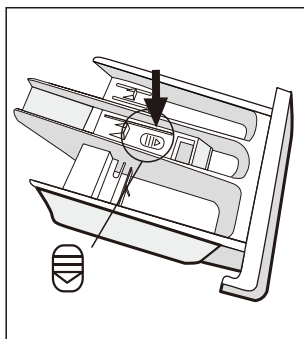

2. Nettoyez le tiroir de l'adoucisseur et le couvercle sous l'eau.

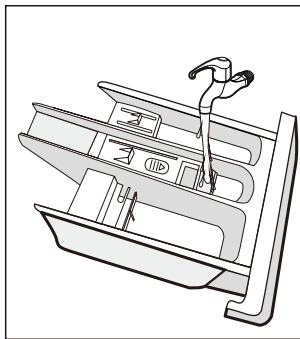

3. Nettoyez le trou avec une brosse douce

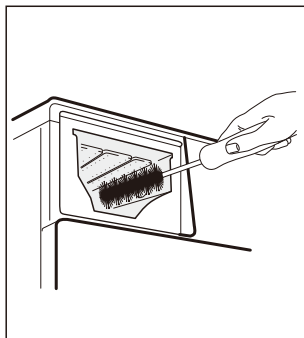

4. Remettre la boîte en place

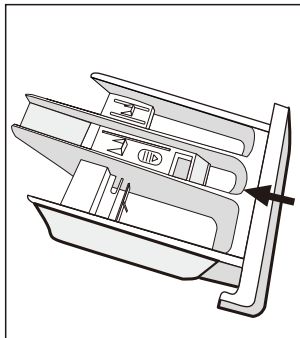

### REMARQUE

- N'utilisez pas d'agents abrasifs ou caustiques pour nettoyer les plastiques.
- Nettoyez le tiroir à détergent tous les 3 mois pour assurer le fonctionnement normal de l'appareil.

# NETTOYAGE ET MAINTENANCE

## Nettoyage du filtre de la pompe de vidange

### AVERTISSEMENT

- Assurez-vous que le lave-linge séchant a terminé son cycle de lavage et qu'il est vide. Éteignez-le et débranchez-le avant de nettoyer le filtre de la pompe de vidange.
- Faites attention à l'eau chaude. Laissez l'eau refroidir. Risque de brûlure.
- Nettoyez le filtre tous les 3 mois pour assurer un fonctionnement normal.

1. Ouvrir le couvercle inférieur

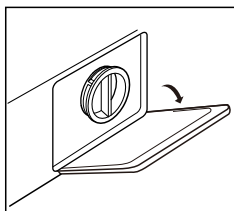

2. Ouvrez le filtre en le tournant comme indiqué sur l'image.

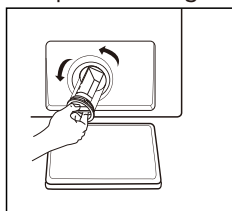

3. Retirer tout objet étranger

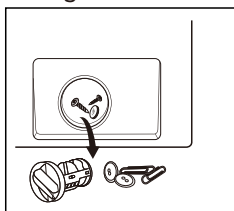

4. Fermez le couvercle inférieur

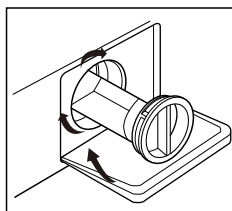

### ATTENTION

- Lorsque l'appareil est en marche et en fonction du programme sélectionné, il peut y avoir de l'eau chaude dans la pompe. Ne retirez jamais le couvercle de la pompe pendant un cycle de lavage, attendez toujours que l'appareil ait terminé le cycle et soit vide. Lorsque vous remettez le couvercle en place, assurez-vous qu'il est bien resserré.

# DÉPANNAGE

Si la machine ne fonctionne pas ou s'arrête pendant le fonctionnement, reportez-vous à ce tableau pour trouver une solution au problème. Si vous ne pouvez pas le résoudre, contactez le service technique.

Description	Cause	Solution
Le lave-linge ne démarre pas	La porte n'est pas bien fermée. Les vêtements sont coincés.	Fermez la porte et vérifiez que le linge n'est pas coincé.
La porte ne s'ouvre pas	Le verrouillage de sécurité a été activé	Débranchez le lave-linge et redémarrez l'appareil.
Fuite d'eau	Les raccords ne sont pas assez serrés.	Vérifiez et serrez les tuyaux d'eau. Nettoyez le tuyau d'évacuation.
Traces de détergent dans le distributeur	Le détergent devient humide ou s'agglomère	Nettoyez et séchez la boîte à détergent.
L'indicateur ou l'affichage ne s'allume pas	La carte n'est pas alimentée, le harnais a un problème de connexion.	Vérifiez si l'appareil est alimenté et si la fiche est correctement branchée.
Bruit anormal	Les vis de transport sont toujours en place. Le sol n'est pas solide ou plat.	Vérifiez si les boulons de fixation ont été retirés. Vérifiez que le lave-linge est installé sur un sol solide et de niveau.

## Codes d'erreur

Description	Cause	Solution
<b>E30</b>	La porte n'est pas bien fermée	Fermez bien la porte et redémarrez.
<b>E10</b>	Problème de prise d'eau pendant le lavage	Vérifiez la pression de l'eau. Redressez le tuyau d'eau. Nettoyer la crépine de la valve d'admission.
<b>E21</b>	Temps excessif de drainage	Vérifiez si le drain est bloqué
<b>E12</b>	Débordement d'eau	Réinitialiser le lave-linge
<b>EXX</b>	Autres	Réinitialisez le lave-linge ou appelez le service après-vente.

# ÉLIMINATION ET RECYCLAGE



**ÉLIMINATION: Ne jetez pas ce produit avec les déchets municipaux non triés. Ces déchets doivent être collectés séparément pour un traitement spécial.**

Conformément à la directive européenne 2012/19 / UE relative aux déchets d'équipements électriques et électroniques (DEEE), les appareils électro-ménagers ne peuvent pas être jetés dans les conteneurs municipaux habituels; Ils doivent être collectés de manière sélective pour optimiser la récupération et le recyclage des composants et des matériaux qui les composent et réduire leur impact sur la santé humaine et l'environnement.

Le symbole de la poubelle barrée est inscrit sur tous les produits pour rappeler aux consommateurs l'obligation de les séparer pour une collecte séparée. Le consommateur doit contacter les autorités locales ou le vendeur pour se renseigner sur l'élimination correcte de son appareil.

## Service après-vente

Les pièces détachées de votre appareil sont disponibles pour une durée minimale de 10 ans, conformément aux exigences d'écoconception de l'ANNEXE II du RÈGLEMENT 2019/2023 DE LA COMMISSION DE L'UNION EUROPÉENNE.

En cas de questions, veuillez contacter notre service clientèle local.



### ADVERTISSEMENT

Risque de choc électrique:

- N'essayez jamais de réparer vous-même un appareil défectueux. Vous pouvez vous mettre en danger ainsi que les autres personnes qui l'utilisent. Les réparations ne peuvent être effectuées que par des spécialistes agréés.
- Les réparations incorrectes annulent la garantie et les dommages qui en résultent ne seront pas reconnus.

## Transport

### ÉTAPES IMPORTANTES POUR LE DÉPLACEMENT DE L'APPAREIL

- Débranchez l'appareil et fermez l'arrivée d'eau.
- Vérifiez que la porte et le boîtier du distributeur sont correctement fermés. Retirez le tuyau d'entrée et de sortie de l'installation domestique.
- Laissez l'eau s'écouler complètement de l'appareil (voir "Nettoyage du filtre de la pompe de vidange").
- Important: réinstallez les 4 vis de transport à l'arrière de l'appareil.
- L'appareil est lourd, transportez-le avec précaution. Ne la tenez jamais par l'une de ses parties saillantes et n'utilisez pas la porte comme poignée.

## CONDITIONS DE GARANTIE

Cet appareil est garanti pendant trois ans à compter de la date de vente contre tout défaut de fabrication, y compris la main-d'œuvre et les pièces de rechange. Afin de prouver la date d'achat, la facture ou le ticket de caisse doit être présenté. Les conditions de cette garantie s'appliquent uniquement à l'Espagne et au Portugal. Si vous avez acheté ce produit dans un autre pays, veuillez consulter votre revendeur pour connaître les conditions applicables.

### EXCLUSIONS DE LA GARANTIE

1. Les télécommandes, les caoutchoucs des bouches d'égout, les serrures et les joints des portes, les coupe-bise.
2. Les dommages causés à l'émail, à la peinture, au nickelage, au chromage, à la rouille ou à d'autres types de pièces ou composants esthétiques qui n'affectent pas le fonctionnement interne de l'appareil.
3. Dommages aux pièces d'usure dus à l'utilisation, à la corrosion ou à l'oxydation, qu'ils soient causés par l'utilisation normale de l'appareil ou par une détérioration accélérée due à des circonstances environnementales ou climatiques défavorables. Ne convient pas à une utilisation en extérieur.
4. Les dommages aux parties fragiles du verre, de la vitrocéramique, des matières plastiques, des poignées, des paniers, des portes ou des ampoules lorsque leur défaillance ou leur rupture n'est pas imputable à un défaut de fabrication.
5. Les pannes produites par des causes fortuites ou des accidents de force majeure, ou résultant d'une utilisation anormale, négligente ou inadéquate de l'appareil.
6. Les responsabilités civiles de toute nature.
7. Les dommages consécutifs à l'appareil pour autant qu'ils n'aient pas été causés par un dysfonctionnement interne.
8. La maintenance ou l'entretien de l'appareil : vérifications périodiques, réglages et graissage.
9. Les pannes que peuvent subir les accessoires et les compléments, les adaptateurs, les câbles externes, les sacs, les pièces détachées de toutes sortes, les lampes, ainsi que toute pièce considérée comme consommable par le fabricant.
10. Les pannes causées par une installation incorrecte ou non légale, une ventilation inadéquate, un manque de mise à la terre dans l'habitation, des altérations courantes, des modifications inappropriées ou l'utilisation de pièces de rechange non originales.
11. Appareils utilisés dans des applications industrielles ou à des fins commerciales.
12. Les appareils dont le numéro de série est illisible ou altéré.
13. Les défauts ou pannes causés à la suite de réparations, de modifications ou de démontage de l'installation de l'appareil par l'utilisateur ou par un technicien non autorisé par le fabricant, ou à la suite du non-respect manifeste des instructions d'utilisation et d'entretien du fabricant.
14. Tous les manuels doivent être conservés avec l'appareil pendant la période de garantie. Si l'équipement est vendu, donné ou cédé, le manuel et tous les documents connexes doivent être remis au nouvel utilisateur. Si l'un de ces documents est perdu, il ne pourra pas être remplacé.
15. Les pannes ayant pour origine ou résultant directement ou indirectement : du contact avec des liquides, des produits chimiques et d'autres substances, ainsi que des conditions liées au climat ou à l'environnement : tremblements de terre, incendies, inondations, chaleur excessive ou toute autre force extérieure, comme les insectes, les rongeurs et autres animaux qui peuvent avoir accès à l'intérieur de la machine ou à ses points de connexion.
16. Les dommages dérivés du terrorisme, de l'émeute, du tumulte populaire, des manifestations et des grèves légales ou illégales ; des actes des Forces Armées ou des Forces de Sécurité de l'Etat en temps de paix ; des conflits armés et des actes de guerre (déclarés ou non) ; de la réaction nucléaire ou des radiations ou de la contamination radioactive ; du défaut ou de la défectuosité des biens ; des événements classés par le Gouvernement National comme "catastrophe ou calamité nationale".

**La conception et les spécifications peuvent être modifiées sans préavis pour améliorer le produit.**



# CONTEÚDO

**PT**

## **3 PRECAUÇÕES DE SEGURANÇA**

3 Instruções de segurança

---

## **7 ESPECIFICAÇÕES**

8 DESCRIÇÃO DO PRODUTO

9 INÍCIO RÁPIDO

12 INSTALAÇÃO

16 OPERAÇÃO

31 LIMPEZA E MANUTENÇÃO

---

35 RESOLUÇÃO DE PROBLEMAS

36 ELIMINAÇÃO E RECICLAGEM

38 GARANTIA

# PRECAUÇÕES DE SEGURANÇA

## Utilização intendida

Este aparelho é apenas para uso doméstico, e destina-se a tecidos adequados para lavagem na máquina. Este aparelho é apenas para uso interior e instalação integrada. Utilizar apenas em conformidade com estas instruções. O aparelho não se destina a uso comercial. Qualquer outra utilização é considerada imprópria e o fabricante não é responsável por quaisquer danos ou lesões resultantes de tal utilização.

Este aparelho destina-se a ser utilizado em ambientes domésticos e similares, como por exemplo:

- Cozinhas de pessoal em lojas, escritórios e outros ambientes de trabalho.
- Casas de campo.
- Para clientes em hotéis, motéis e outros ambientes de tipo residencial.
- Ambientes de bed & breakfast.
- Áreas comuns em apartamentos ou lavandarias de blocos de apartamentos.

## Explicação dos símbolos



### PERIGO

Este símbolo indica que existem perigos para a vida e a saúde das pessoas devido a gás extremamente inflamável.



### AVISO DE TENSÃO ELÉCTRICA

Este símbolo indica que existe um perigo para a vida e a saúde das pessoas devido à tensão.



### ADVERTÊNCIA

A palavra de sinalização indica um perigo com um nível médio de risco que, se não for evitado, pode resultar em morte ou ferimentos graves.



### ATENÇÃO

A palavra de sinalização indica um perigo com um baixo grau de risco que, se não for evitado, pode resultar em ferimentos ligeiros ou moderados.



### NOTA

A palavra de sinalização indica informações importantes (por exemplo, danos materiais), mas não perigo.



### OBSERVAR AS INSTRUÇÕES

Este símbolo indica que um técnico de assistência só deve operar e efectuar a manutenção deste aparelho de acordo com o manual de instruções.

Para sua segurança, deve seguir as informações deste manual para minimizar o risco de incêndio ou explosão, choque eléctrico, e para evitar danos materiais, ferimentos pessoais ou morte. O não cumprimento destas instruções anulará a garantia.

Este aparelho não se destina a ser utilizado por pessoas (incluindo crianças) com capacidades físicas, sensoriais ou mentais reduzidas, ou com falta de experiência e conhecimentos, excepto se tiverem recebido supervisão ou instruções relativas à utilização do aparelho por uma pessoa responsável pela sua segurança.

## ADVERTÊNCIA: Choque eléctrico

- Se o cabo de alimentação for danificado, deve ser substituído pelo fabricante, pelo seu agente de serviço ou por pessoas com qualificações semelhantes, a fim de evitar um perigo.
- Se a máquina for danificada, não deve ser utilizada até ter sido reparada pelo fabricante, pelo seu agente de serviço ou por pessoas com qualificações semelhantes, a fim de evitar um risco de choque eléctrico.
- O aparelho pode ser utilizado por crianças a partir dos 8 anos de idade e por pessoas com capacidades físicas, sensoriais ou mentais reduzidas ou com falta de experiência e conhecimentos, se lhes tiver sido dada supervisão ou instruções relativas à utilização do aparelho de uma forma segura e compreender os perigos envolvidos. As crianças não devem brincar com o aparelho e não devem efectuar a limpeza e a manutenção do utilizador sem supervisão.
- As crianças devem ser supervisionadas para garantir que não brincam com o aparelho.
- As crianças com menos de 3 anos de idade devem ser afastadas ou supervisionadas continuamente para garantir que não brincam com o aparelho.
- Animais e crianças podem entrar na máquina. Verificar o interior antes de ligar o aparelho.
- Não subir nem sentar-se em cima do aparelho.

## Localização e ambiente de instalação

- Armazenar todos os detergentes e produtos de lavagem num local seguro, fora do alcance das crianças.
- Não instalar a máquina em tapetes. Se as aberturas da máquina de lavar roupa forem obstruídas, a máquina pode avariar-se.
- Manter o aparelho afastado de fontes de calor e da luz solar direta para evitar a corrosão de peças de plástico e borracha.
- Não utilizar o aparelho em ambientes húmidos ou salas que contenham gás explosivo ou cáustico. Em caso de fuga de água ou salpicos que afectem a máquina, deixá-la secar ao ar livre.
- O aparelho não deve ser instalado atrás de portas com fechadura, portas de correr ou portas com a dobradiça do lado oposto ao da máquina de lavar.
- Não utilizar esta máquina em salas com uma temperatura inferior a 5°C, pois isso pode causar danos em alguns dos seus componentes. Se for inevitável, certifique-se de que drena completamente a máquina após cada utilização (ver "Limpeza do filtro da bomba de drenagem") para evitar danos causados pelo gelo.
- Nunca utilizar sprays ou substâncias inflamáveis perto do aparelho.

## Instalação

- Remover todos os parafusos de embalagem e transporte antes de utilizar o dispositivo. Não o fazer pode resultar em danos graves.
- Este aparelho está equipado com uma única válvula de entrada e só pode ser ligado ao abastecimento de água fria.
- A ficha deve permanecer acessível após a instalação.
- Antes de lavar a roupa pela primeira vez, fazer funcionar o aparelho num ciclo quente sem roupa no interior para a sua limpeza.
- Antes de utilizar a máquina de lavar, esta deve ser calibrada.
- Não colocar objectos pesados ou aquecedores sobre o aparelho.

# PRECAUÇÕES DE SEGURANÇA

- Utilizar as novas mangueiras fornecidas com o aparelho, não reutilizar as mangueiras velhas.
- Pressão máxima de entrada de água: 1 MPa. Pressão mínima de entrada de água: 0,05 MPa.

## Ligação eléctrica

- Certificar-se de que o cabo de alimentação não fica preso debaixo da máquina, pois isto pode causar danos.
- Ligar o produto a uma tomada com ligação à terra protegida por um fusível que cumpra as classificações da tabela "Especificações Técnicas". A instalação da ligação à terra deve ser efectuada por um electricista qualificado. Certificar-se de que a máquina é instalada de acordo com os regulamentos locais.
- As ligações eléctricas e de água devem ser feitas por um técnico qualificado, de acordo com as instruções do fabricante e os regulamentos de segurança locais.



## ADVERTÊNCIA

- Não utilizar tiras de potência ou cordões de extensão.
- O aparelho não deve ser equipado com um dispositivo de comutação externo tal como um temporizador, nem deve ser ligado a um circuito que é ligado e desligado frequentemente.
- Não retirar a ficha da tomada se estiver presente gás inflamável.
- Nunca desligue o aparelho com as mãos molhadas.
- Puxe sempre a ficha, não o cordão.
- Desligar o aparelho quando não estiver a ser utilizado.

## Ligações de água

- Verificar as ligações dos tubos de entrada de água, torneira de água e tubo de drenagem para detectar problemas devido a alterações na pressão da água. Se as ligações estiverem soltas ou com fugas, feche a torneira e repare-a.
- Não utilizar o aparelho antes de verificar se as tubagens e ligações estão devidamente instaladas por técnicos qualificados.
- A porta de vidro pode ficar muito quente durante o funcionamento. Manter as crianças e os animais de estimação afastados da máquina enquanto esta está a funcionar.
- Os tubos de entrada e saída de água devem ser instalados de forma segura e não devem ser danificados ou podem ocorrer fugas de água.
- Não remover o filtro da bomba de drenagem enquanto a água permanecer no aparelho. Grandes quantidades de água quente podem derramar, o que pode causar queimaduras.

## Operação e manutenção

- Nunca utilizar solventes inflamáveis, explosivos ou tóxicos. Substâncias tais como gasolina, álcool, etc. não devem ser utilizadas como detergentes. Escolher apenas detergentes adequados para a lavagem à máquina.
- Certifique-se de que todos os bolsos das peças de vestuário estão vazios. Objectos afiados e rígidos tais como moedas, broches, pregos, parafusos ou pedras, ou objectos inflamáveis tais como isqueiros e fósforos podem causar sérios danos à máquina.
- Lavar bem a roupa lavada à mão.

- O vestuário que tenha sido sujo com substâncias como óleo de cozinha, acetona, álcool, gasolina, querosene, remove-dores de manchas, aguarrás, ceras e removedores de cera devem ser lavados em água quente com uma quantidade extra de detergente antes de secar na máquina
- Artigos tais como tecidos de espuma de borracha (espuma de látex), toucas de duche, tecidos impermeáveis, artigos apoiados em borracha e vestuário ou almofadas de espuma de borracha não devem ser secos na máquina.
- Os amaciadores de tecidos ou produtos similares devem ser utilizados conforme especificado nas instruções do amaciador.
- Não forçar a porta a abrir. Irá desbloquear pouco depois de o ciclo estar completo.
- Não fechar a porta com força excessiva. Se tiver dificuldade em fechar a porta, verifique se a roupa está bem distribuída.
- Desligar sempre o aparelho da tomada e fechar a torneira antes da limpeza ou manutenção e após cada utilização.
- Nunca deitar água sobre o aparelho para limpeza, pode causar um choque eléctrico.
- As reparações devem ser efectuadas pelo fabricante, o seu departamento de serviços ou outros profissionais qualificados, a fim de evitar riscos. O distribuidor não é responsável por quaisquer danos causados por pessoas não autorizadas.

## Transporte

- Antes de transportar:
  - Os parafusos de transporte devem ser reinstalados por um profissional qualificado.
  - A água acumulada deve ser drenada da máquina.
- Este aparelho é pesado, transportá-lo com cuidado. Nunca segure qualquer parte saliente da máquina ao levantá-la. A porta da máquina não pode ser utilizada como puxador.

Modelo	Capacidade de lavagem
ADRA100	10.0kg
ADRA120	12.0kg

# ESPECIFICAÇÕES

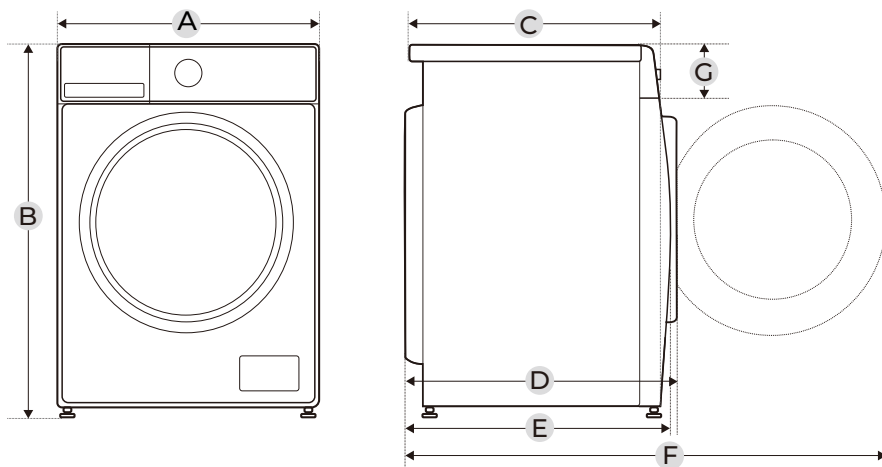

Modelo	ADRA100	ADRA120
Alimentação	220-240V~,50Hz	
Corrente máxima	10A	
Pressão de água padrão	0.05MPa~1MPa	
Capacidade lavagem	10.0kg	12.0kg
<b>Dimensões</b>		
A	595mm	595mm
B	850mm	850mm
C	530mm	595mm
Peso	65kg	73kg
Potência nominal	2000W	2000W
<b>Dimensões de referência</b>		
D	600mm	660mm
E	540mm	641mm
F	1045mm	1105mm
G	135mm	135mm

# DESCRIÇÃO DO PRODUTO

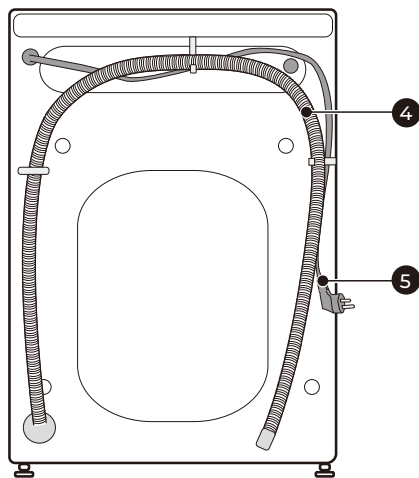
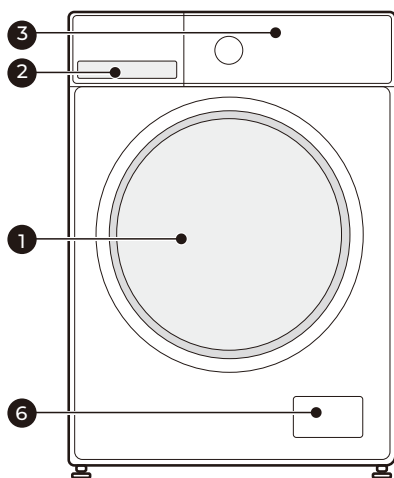

1	Porta
2	Distribuidor de detergente
3	Control panel

4	Mangueira de drenagem
5	Cabo de alimentação
6	Filtro de serviço

## ● NOTA

A ilustração é apenas para referência, referir-se sempre ao produto real como padrão.

## Acessórios

4 x plugues

1 x tubo de entrada de água fria

1 x Manual de instruções

Esponja acústica (opcional)

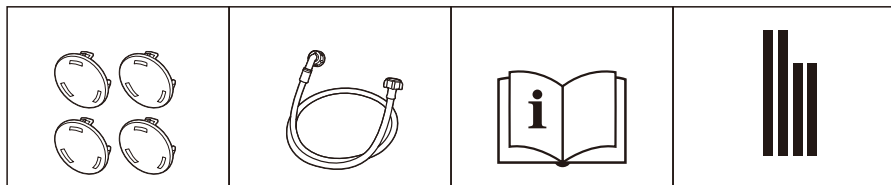

# INÍCIO RÁPIDO

## ATENÇÃO

- Antes da lavagem, certifique-se de que a máquina está correctamente instalada.
- O seu aparelho foi cuidadosamente verificado antes de sair da fábrica. Para eliminar os resíduos de água e neutralizar os eventuais odores, recomenda-se a limpeza do aparelho antes da primeira utilização. Por este motivo, recomenda-se a limpeza do tambor interior através do programa "Limp. tambor" ou outro programa com a temperatura opcional de 90°C.
- Tenha cuidado para não colocar roupa e detergente na máquina.

## Calibração

Recomenda-se a calibração da máquina de lavar para melhores resultados.

O aparelho pode detectar a quantidade de carga a ser inserida. Esta função optimiza o desempenho do produto ao minimizar o consumo de energia e água, poupando assim tempo e dinheiro ao utilizador. Por este motivo, sugerimos que o calibre seguindo os passos abaixo indicados:

- 1- Retirar todos os acessórios do tambor e fechar a porta.
- 2- Ligar a máquina de lavar à tomada principal.
- 3- Ligar a máquina e premir "Centrifug." durante 10 segundos, até ser afixado "t19".
- 4- Premir  para ligar o aparelho, inicialmente aparece "---" e depois "\*\*\*\*" (por exemplo, "126") para indicar a velocidade do tambor em tempo real. Quando o número atinge um determinado valor (para de mudar), significa que a máquina de lavar roupa foi calibrada com êxito.



## 1. Antes da lavagem

### 1. Ligue

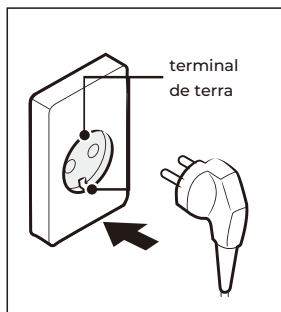

### 2. Abra a torneira

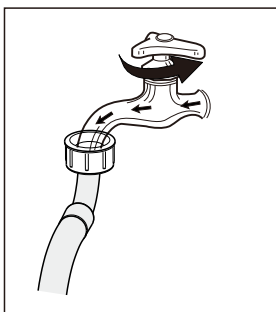

### 3. Carregue a roupa

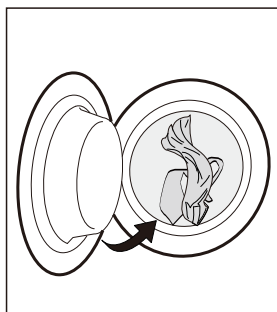

### 4. Feche a porta

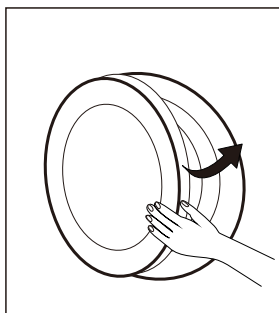

### 5. Adicione detergente

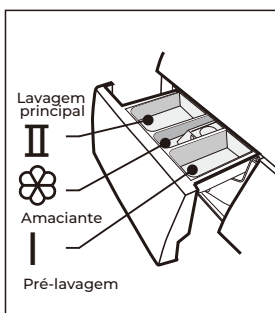

### ● NOTA

Deve adicionar o detergente na caixa I se seleccionar pré-lavagem.

## 2. Lavagem

### 1. Escolha o programa

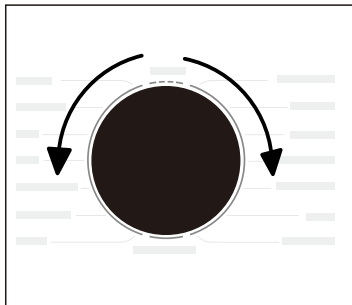

### 2. Seleccionar função ou manter função padrão

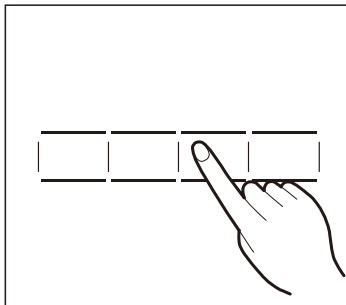

### 3. Prima Iniciar/Pausa para iniciar a lavagem

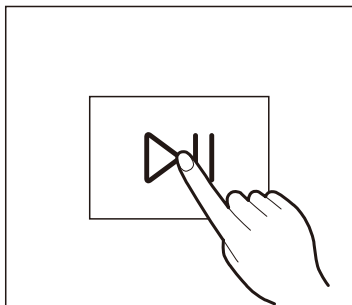

#### ● NOTA

- 1: Se for seleccionada a predefinição, o passo 2 pode ser ignorado.
- 2: O gráfico de linha do botão de função é apenas para referência, consulte o produto real como padrão.

## 3. Após a lavagem

A campainha soa e "End" aparece no visor.

# INSTALAÇÃO

 Ferramentas necessárias para a instalação pelo próprio (não incluídas)

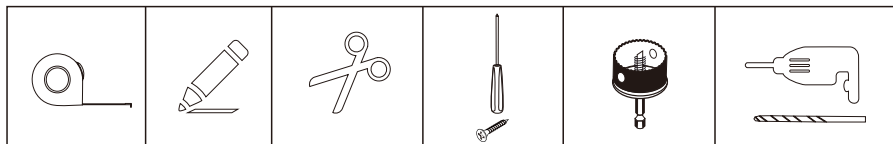

## Área de instalação

### ADVERTÊNCIA

- A estabilidade é importante para evitar que o produto se desloque. Certifique-se de que a máquina está nivelada e estável.
- Certifique-se de que o produto não fica em cima do cabo de alimentação.
- Certifique-se de que mantém as distâncias mínimas em relação às paredes, tal como indicado na imagem.

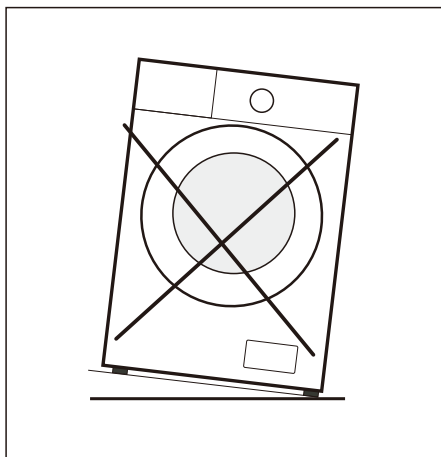
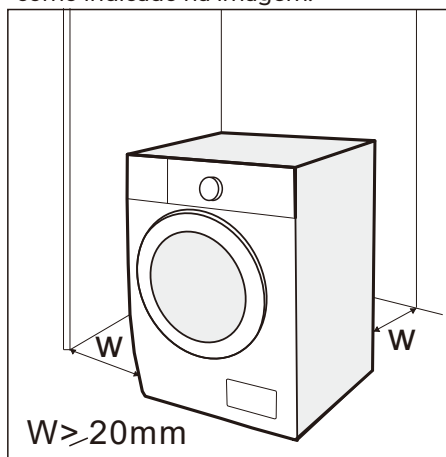

Antes de instalar a máquina, deve ser seleccionado um local que satisfaça as seguintes características:

1. Superfície rígida, seca e nivelada
2. Sem luz solar direta
3. Ventilação suficiente
4. Temperatura ambiente acima de 5°C
5. Longe de fontes de calor, tais como fogões a carvão ou a gás.

## Desembalar a máquina de lavar

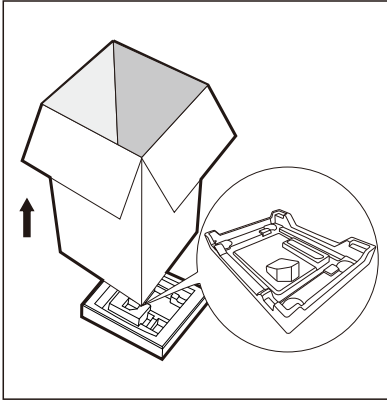

### ⚠ ADVERTÊNCIA

- O material de embalagem (tal como plástico e isopor) pode ser perigoso para as crianças.
- Há um risco de asfixia. Manter todas as embalagens afastadas das crianças.

1. A estabilidade é importante para evitar que o produto se desloque.
2. Certifique-se de que a máquina de lavar e secar está nivelada e estável.
3. Certifique-se de que o aparelho não repousa sobre o cabo de alimentação.
4. Certifique-se de que as distâncias mínimas das paredes mostradas na imagem são observadas.

## Retirar os parafusos de transporte

### ⚠ ADVERTÊNCIA

Retirar os parafusos de transporte da parte de trás antes de utilizar o produto.

1. Desaperte os 4 parafusos de transporte com uma chave inglesa.

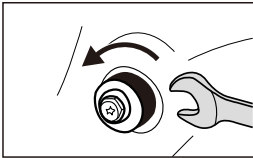

2. Retirar os parafusos e as anilhas de borracha e guardá-los para utilização futura.

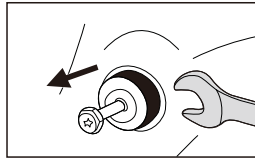

3. Fechar os buracos com as tampas.

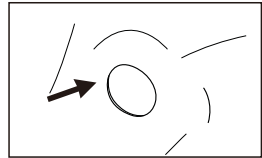

# INSTALAÇÃO

## Equilibrar a máquina de lavar

### ⚠ ADVERTÊNCIA

As quatro porcas das pernas devem ser apertadas com segurança.

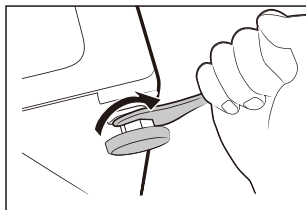

1. Desaperte a porca de segurança.
2. Rodar a perna até tocar o chão.
3. Ajustar as pernas e bloquear as porcas com uma chave inglesa. Verificar se a máquina de lavar está equilibrada e estável.

## Ligar a tubagem de entrada de água

### ⚠ ADVERTÊNCIA

Para evitar fugas ou danos causados pela água, seguir as instruções abaixo.

- Não dobrar, esmagar, modificar ou cortar o tubo.

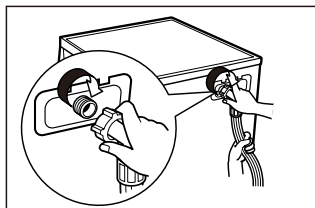

Ligar a mangueira de abastecimento de água à válvula de entrada de água e a uma torneira de água fria, conforme demonstrado.

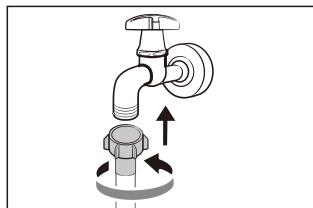

### ● NOTA

- Fazer a ligação manualmente, sem ferramentas. Verificar se as ligações estão apertadas.

## Tubo de drenagem

### ⚠ ADVERTÊNCIA

- Não dobrar ou estender o tubo de drenagem.
- Posicione correctamente a mangueira de drenagem, caso contrário podem ocorrer danos que provoquem fugas de água.
- Não é permitido remover a fivela do tubo de drenagem.

Há duas maneiras de ligar a extremidade do tubo de drenagem:

### 1. Para o dreno principal

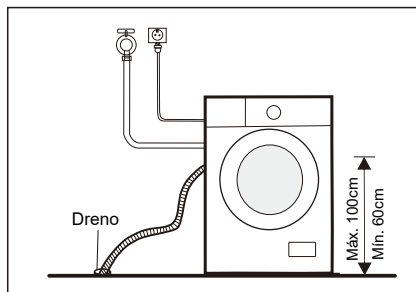

### 2. Ligá-lo a um ramo do dreno principal.

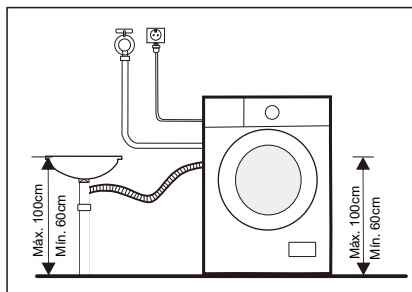

## Esponja acústica

### ● NOTA

- Certifique-se de que monta as esponjas acústicas, que podem reduzir eficazmente o ruído causado pela máquina durante o funcionamento, de modo a proporcionar-lhe um ambiente de vida mais tranquilo e silencioso.

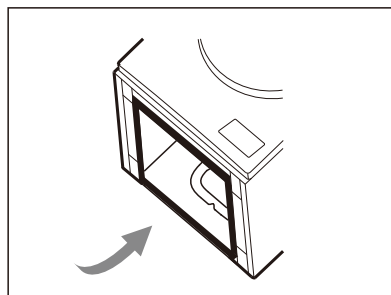
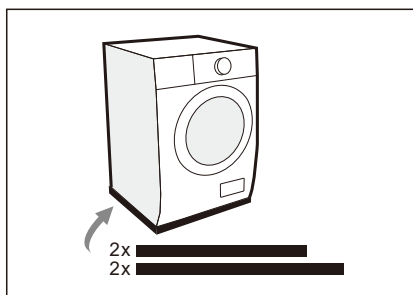

1. Colocar a máquina de lavar e secar no chão utilizando algum material macio, como espuma ou roupa para proteção.
2. Colar as duas esponjas mais compridas nos bordos inferiores mais compridos e as duas esponjas mais curtas nos bordos mais curtos.

# OPERAÇÃO

## Antes de cada lavagem

- O intervalo de temperatura ambiente de funcionamento da máquina de lavar deve estar entre 5-40°C. Se utilizado abaixo de 0°C, a válvula de entrada e o sistema de drenagem podem ser danificados. Se o aparelho for instalado em condições muito frias, deve ser mudado para a temperatura ambiente normal para garantir que as tubagens de abastecimento de água e de drenagem sejam descongeladas antes da sua utilização.
- Verificar as etiquetas de detergente e as instruções antes de usar.
- Utilizar detergente não espumante adequado para a lavagem de máquinas.

1. Tire tudo o que tem nos bolsos

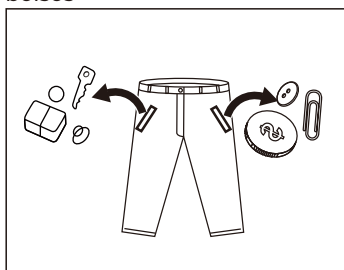

2. Separe as peças de vestuário de acordo com a cor e textura.

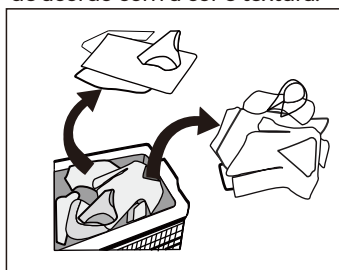

3. Atar as fitas, fechar fechos de correr e botões

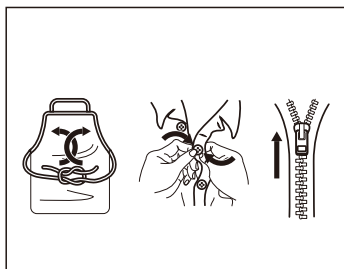

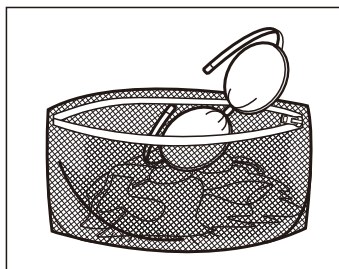

4. Colocar pequenas peças de vestuário numa capa



### ⚠ ADVERTÊNCIA

- Não lavar artigos que tenham estado em contacto com querosene, gasolina, álcool, cera, óleo, tinta e outras substâncias inflamáveis.
- A lavagem de uma única peça de vestuário pode desequilibrar a máquina de lavar e desencadear um alerta. É aconselhável adicionar mais um ou dois itens para equilibrar a lavagem e a centrifugação.
- Não lavar, secar ou secar assentos, tapetes ou vestuário à prova de água.





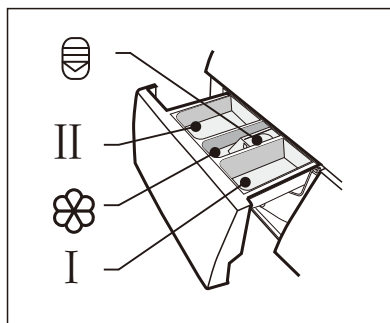













## Distribuidor de detergente

- I Pré-lavagem
- II Lavagem principal
-  Amaciante
-  Botão para remover o doseador



### ATENÇÃO

- Só se deve adicionar detergente ao compartimento "I" depois de seleccionar a função de pré-lavagem.







Programa	I	II / 		Programa	I	II / 	
Algodón/Algodão  ○	●	○	○	(Centrifug.) 			
Sintéticos  ○	●	○	○	R. de cama  ○	○	●	○
Mix  ○	●	○	○	Lana/Lã  ○		●	○
Sport  ○	●	○	○	Express 15'  ○		●	○
R. Bebê  ○	●	○	○	Rápido 45'  ○		●	○
Jeans  ○	●	○	○	20°C ○		●	○
ECO 40-60  ○	●	○	○	VapCare  ○	○	●	○
Limp. tambor  ○							

- Necessário
- Opcional



# OPERAÇÃO

## Recomendação de detergente

Recomendação de detergente	Tipo de tecido	Ciclos de lavagem	Temperat. lavagem °C
Detergente de alta resistência com agentes branqueadores e abrillantadores ópticos.	Roupas de cama de algodão ou linho à prova de fervura	Algodón/Algodão  ECO 40-60 	40/60
Detergente para roupa de cor sem branqueador e abrillantadores ópticos	Roupa colorida feita de algodão ou linho	Algodón/Algodão 	20/40
Detergente de cor ou suave sem abrillantadores ópticos	Roupa colorida feita de fibras de fácil manutenção ou materiais sintéticos	Algodón/Algodão  Sintéticos 	20/40
Detergente de lavagem suave	Tecidos delicados, seda, viscose	Sintéticos 	20
Detergente especial para lã	Lã	Lana/Lã 	20/40

### NOTA

- É aconselhável diluir detergentes ou amaciadores mais espessos com água para evitar que a entrada do detergente bloqueie e transborde quando cheio com água.
- Escolha um tipo de detergente adequado para diferentes temperaturas de lavagem e obtenha o melhor desempenho com menos consumo de água e energia.
- Para melhores resultados de lavagem, é importante dosear o detergente. Utilizar uma quantidade reduzida se o tambor não estiver completamente cheio.
- Ajustar sempre a quantidade de detergente à dureza da água. Se for macio, usar menos detergente.
- Dosear o detergente de acordo com o nível de sujidade da roupa suja.
- O detergente de alta concentração (compacto) requer uma dosagem particularmente precisa.

Os seguintes sintomas são um sinal de detergente em demasia:

- alta formação de espuma
- maus resultados de lavagem e enxaguamento

Os seguintes sintomas são sinais de falta de detergente:

- a roupa fica cinzenta
- acumulação de depósitos de calcário no tambor, no elemento de aquecimento ou na roupa.

## Painel de controlo

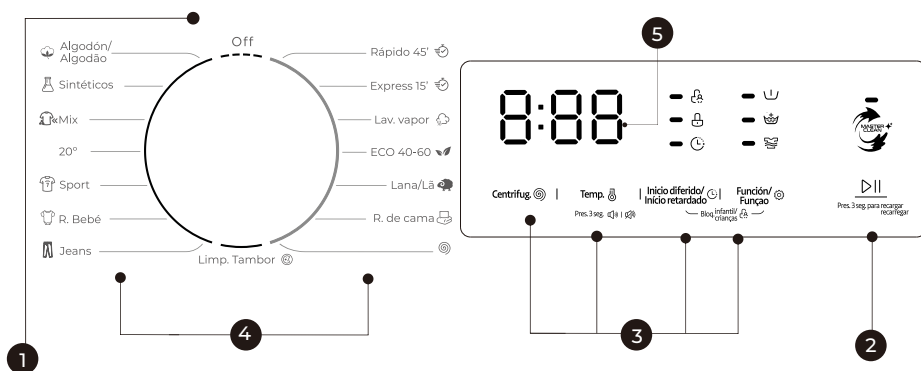

### 1 OFF

Desligar o aparelho.

### 2 Início/Pausa

Iniciar ou interromper o programa.

### 3 Opções

Permite seleccionar funções adicionais e acende-se quando seleccionada.

### 4 Programas

Disponível de acordo com o tipo de roupa.

### 5 Ecrã

O ecrã apresenta as definições, o tempo restante estimado, as opções e as mensagens de estado.

### NOTA

- O gráfico é apenas uma referência, por favor consulte o produto real como padrão.

# OPERAÇÃO

## Display

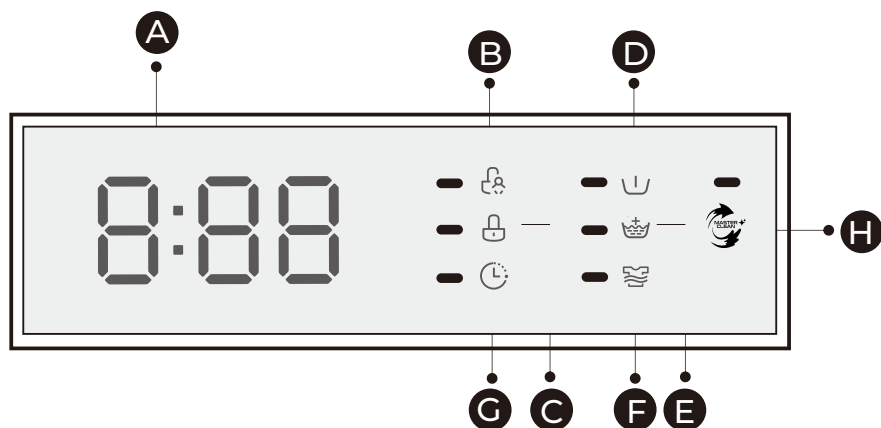

### A Display

Lavagem

125

Velocidade

400

Fim

End

Tempo diferido

2H

Erro

E30

Temp.

30

### B Bloqueio crianças

### C Bloqueio porta

### D Pré-lavagem

### E Enxaguamento extra











### F Lavagem intensiva

### G Diferido

### H MASTER CLEAN

## Programas





Modelo: ADRA100; ADRA120

Programas	Carga (kg)		Tempo exibido (h:min)	
	10.0	12.0	10.0	12.0
Algodón/Algodão 	10.0	12.0	3:49	3:49
Sintéticos 	5.0	6.0	3:28	3:28
Mix 	10.0	12.0	1:30	1:30
20°C	5.0	6.0	1:11	1:11
Sport 	5.0	6.0	0:57	0:57
R. Bebê 	10.0	12.0	1:52	1:52
Jeans 	10.0	12.0	1:56	1:56
VapCare 	5.0	6.0	1:58	1:58
(Centrifug.) 	10.0	12.0	0:12	0:12
R. de cama 	10.0	12.0	1:48	1:48
Lana/Lã 	2.0	2.0	1:07	1:07
ECO 40-60 	10.0	12.0	3:59	4:00
Limp. tambor 	--	--	1:28	1:28
Express 15' 	2.0	2.0	0:15	0:15
Rápido 45' 	2.0	2.0	0:45	0:45

### NOTA





- Os parâmetros desta tabela são apenas para referência do utilizador. Os parâmetros reais podem ser diferentes dos parâmetros da tabela acima mencionada.

ADRA100

Ciclo	Capacidade nominal em kg	Ajuste de temperatura °C	Duração do ciclo em h:min	Consumo de energia em kWh/ciclo	Consumo de água em litros/ciclo	Temperatura máxima °C <sup>1)</sup>	Humidade residual em % / velocidade de centrifugação em rpm <sup>2)</sup>
Algodón/ Algodão 	10.0	60	3:54	1.726	85	60	53%/1400
Mix 	10.0	40	1:30	0.889	85	40	70%/800
20 °C	5.0	20	1:11	0.212	51	20	65%/1000
Express 15' 	2.0	Fria	0:15	0.030	31	Fria	70%/800
R. de cama 	10.0	40	1:48	0.920	85	40	65%/1000
ECO 40-60 <sup>3)</sup> 	10.0	--	3:59	0.895	67.0	41	53.9%/1350
	5.0	--	3:00	0.560	52.0	33	53.9%/1350
	2.5	--	3:00	0.232	41.5	23	53.9%/1350

- Os dados acima referidos são apenas para referência e podem variar devido a alterações nas condições reais de utilização.
- Os valores para outros programas que não o programa ECO 40-60 são apenas indicativos.
- 20°C é capaz de limpar roupa de algodão ligeiramente suja, a uma temperatura nominal de 20°C, o que está em conformidade com o regulamento (UE) 2019/2023.
- De acordo com EN 60456:2016/prA2019 con (EU)2019/2014, (EU)2019/2023, (EU)2021/340, (EU)2021/341, a nova classe de eficiência energética da UE é: A
- Programa de teste de energia: ECO 40-60. Todos os outros: por defeito.
- Meia carga para máquina de 10.0Kg: 5.0Kg. Carga de um quarto para máquina de 10.0kg: 2.5Kg.

ADRA120

Ciclo	Capacidade nominal em kg	Ajuste de temperatura °C	Duração do ciclo em h:min	Consumo de energia em kWh/ciclo	Consumo de água em litros/ciclo	Temperatura máxima °C <sup>1)</sup>	Humidade residual em % / velocidade de centrifugação em rpm <sup>2)</sup>
Algodón/ Algodão 	12.0	60	3:54	1.936	99	60	53%/1400
Mix 	12.0	40	1:30	1.006	99	40	70%/800
20 °C	6.0	20	1:11	0.224	58	20	65%/1000
Express 15' 	2.0	Fria	0:15	0.030	31	Fria	70%/800
R. de cama 	12.0	40	1:48	1.037	99	40	65%/1000
ECO 40-60 <sup>3)</sup> 	12.0	--	4:00	1.186	82.0	42	53.9%/1350
	6.0	--	3:00	0.618	58.0	32	53.9%/1350
	4.0	--	3:00	0.254	46.0	24	53.9%/1350

- Os dados acima referidos são apenas para referência e podem variar devido a alterações nas condições reais de utilização.
- Os valores para outros programas que não o programa ECO 40-60 são apenas indicativos.
- 20°C é capaz de limpar roupa de algodão ligeiramente suja, a uma temperatura nominal de 20°C, o que está em conformidade com o regulamento (UE) 2019/2023.
- De acordo com EN 60456:2016/prA2019 con (EU)2019/2014, (EU)2019/2023, (EU)2021/340, (EU)2021/341, a nova classe de eficiência energética da UE é: A
- Programa de teste de energia: ECO 40-60. Todos os outros: por defeito.
- Meia carga para máquina de 12.0Kg: 6.0Kg. Carga de um quarto para máquina de 12.0kg: 3.0Kg.

## Programas

- 1) A temperatura mais alta alcançada pela lavandaria no ciclo de lavagem durante pelo menos 5 minutos.
- 2) Humidade residual após o ciclo de lavagem em percentagem do conteúdo de água e velocidade de centrifugação em que foi alcançada.
- 3) O programa ECO 40-60 permite lavar artigos de algodão moderadamente sujos que são laváveis a 40°C ou 60°C, juntos no mesmo ciclo. O programa é utilizado para medir a conformidade com (EU) 2019/2023.

Os programas mais eficientes em termos energéticos são geralmente aqueles que funcionam a temperaturas mais baixas durante períodos de tempo mais longos.

O enchimento da máquina de lavar roupa até à capacidade indicada para cada programa contribuirá para a poupança de energia e água.

O ruído e o teor de humidade residual dependem da velocidade de centrifugação: quanto maior for a velocidade na fase de centrifugação, maior será o ruído e menor será o teor de humidade residual.

















### **ATENÇÃO**

- Se houver uma interrupção da alimentação eléctrica durante o funcionamento da máquina, uma memória especial guarda o programa seleccionado. A máquina continuará o programa quando a alimentação eléctrica for restabelecida.

# OPERAÇÃO

Disponível de acordo com o tipo de tecido:

Programmes	
Algodón/ Algodão 	Têxteis resistentes ao desgaste, têxteis resistentes ao calor feitos de algodão ou linho.
Rápido 45' 	Lavagem rápida de pouca roupa e pouco suja.
Sintéticos 	Para lavar artigos sintéticos, tais como camisas, casacos, tecidos misturados. Para lavar tecidos de malha, deve reduzir a quantidade de detergente devido à composição dos fios soltos e ao fácil aparecimento de bolhas.
R. bebé 	Para lavar roupa de bebé, pode limpá-la mais cuidadosamente e tornar o enxaguamento mais eficaz para proteger a pele do bebé.
Jeans 	Especialmente para jeans.
Mix 	Carga mista constituída por têxteis de algodão e sintéticos.
20°C	Capaz de limpar roupa de algodão ligeiramente suja, a uma temperatura nominal de 20 °C.
Sport 	Lavar a roupa de desporto.
Express 15' 	Programa extra curto, adequado para roupa pouco carregada e com pouca sujidade.
R. de cama 	Especialmente concebido para a lavagem de peças de vestuário volumosas.
Lana/Lã 	Têxteis de lã ou de lã nobre laváveis à mão ou à máquina. Programa de lavagem especialmente suave para evitar o encolhimento, pausas mais longas no programa (os têxteis repousam no líquido de lavagem).
(Centrifug.) 	Roda e esvazia a água.
ECO 40-60 	Capaz de limpar roupa de algodão com sujidade normal declarada para ser lavada a 40 °C ou 60 °C, no mesmo ciclo.
VapCare 	Steam is applicable for daily laundries.
Limp. tambor 	Este programa foi concebido para limpar o tambor e o tubo. Aplica a esterilização a alta temperatura de 90°C para tornar a lavagem da roupa mais amiga do ambiente. Ao executar este programa, a lavagem da roupa ou outras lavagens não podem ser acrescentadas. Quando se coloca a quantidade certa de cloro branqueador, o efeito de limpeza do tambor será melhor. O cliente pode utilizar regularmente este programa de acordo com as suas necessidades.























































## ● NOTA

- O gráfico é apenas uma referência, consulte o produto real como padrão.
- Quando o programa terminar, "End" piscará no visor, seleccione o botão para a posição Off.



# OPERAÇÃO

## Opções

Cycle	Temperatura por defeito (°C)	Velocidade de centrifugação predefinida (rpm)	Funções adicionais
		1400	
Algodón/Algodão 	40	1400	   
Sintéticos 	40	1200	   
Mix 	40	800	   
20°C	20	1000	 
Sport 	20	800	  
R. Bebê 	60	1000	   
Jeans 	60	800	  
Limp. Tambor 	90	--	
(Centrifug.) 	--	1000	
R. de cama 	40	1000	   
Lana/Lã 	40	600	 
ECO 40-60 	--	1400	
VapCare 	40	1000	   
Express 15' 	Cold	800	
Rápido 45' 	20	800	 

## NOTA

- Ver a velocidade máxima de centrifugação, duração e outros detalhes do programa ECO 40-60 no cartão do produto.
- A tabela mostra as opções oferecidas por cada ciclo, e se alguma definição não estiver disponível para um programa.



### Velocidade de centrifugação

Se necessário, pode ajustar a velocidade de centrifugação pressionando o botão Centrifug., na seguinte sequência: 1400:0-400-600-800-1000-1200-1400



### Início retardado

1. Seleccionar um programa.
2. Prima o botão Início diferido/Início retardado para escolher o tempo de atraso 0-24H.
3. Prima [Início/Pausa] para iniciar a operação de atraso.



Seleccionar um programa. Tempo de regulação Início

Para cancelar a função Início retardado, prima o botão "Início diferido/Início retardado" antes de iniciar o programa até que o visor mostre 0 H. Se o programa já tiver começado, desligue o aparelho e volte a ligá-lo e seleccione um novo programa.



### Pré-lavagem

Função de lavagem extra antes do ciclo de lavagem principal começar a aumentar o rendimento de lavagem.

Nota: O detergente deve ser adicionado ao compartimento I.



### Enxaguamento extra

A roupa será submetida a um enxaguamento suplementar depois de seleccionar esta função.



### Lavagem intensiva

A roupa muito suja pode ser escolhida, seleccionada para aumentar o tempo de lavagem e a intensidade para aumentar o efeito de lavagem.



### MASTER CLEAN

Quando a luz MASTER CLEAN está acesa, esta função é automaticamente activada no programa. A função será activada de forma automática durante cada ciclo de lavagem. O sistema manterá a sua roupa sempre limpa.



### Temp.

Quando necessário, a temperatura de lavagem pode ser ajustada premindo o botão de temperatura nos passos seguintes:

Frio -20°C-30°C - 40°C- 60°C - 90°C.

## NOTA

### Contador de utilização

1. Desligar o equipamento durante 10s e voltar a ligar.
2. Ligar e, no espaço de 10s, premir simultaneamente e continuamente "Centrifug." e "Función/Função" no painel de controlo durante cerca de 5s até o visor do aparelho apresentar dígitos - o valor pode indicar os tempos de utilização do equipamento.
3. Repetir novamente o passo 1 e o cliente pode retomar o funcionamento normal.

# OPERAÇÃO



## Bloqueio para crianças

Para evitar que as crianças não o utilizem correctamente.



Prima Inicio diferido/Inicio retardado e Función/Função simultaneamente durante 3 seg. até ouvir o sinal sonoro. O indicador de bloqueio para crianças liga-se.

## ⚠ ATENÇÃO

Quando o bloqueio para crianças está activado, o visor apresenta alternadamente "CL" e o tempo restante.

Ao premir qualquer outro botão, o indicador de bloqueio para crianças fica intermitente.

Quando o programa termina, "CL" e "End" aparecem alternadamente no ecrã. O bloqueio para crianças desactiva a função de todos os botões, excepto o botão de bloqueio para crianças. Só a pressão simultânea dos dois botões Inicio diferido/Inicio retardado e Función/Função pode desactivar o bloqueio para crianças!

Desactive o Bloqueio de crianças antes de seleccionar um novo programa.



## Silenciar alertas



Escolha o programa



Prima o botão Temp. durante 3 segundos para silenciar os alertas.

Para activar o som dos sinais sonoros, premir novamente o botão durante 3 segundos. O ajuste permanecerá até que o altere novamente.

## ⚠ ATENÇÃO

- Depois de silenciar a função de campainha, os alertas deixarão de tocar.



## Recargar

Esta operação pode ser executada durante o processo de lavagem. Quando o tambor ainda está em rotação e com grande quantidade de água com temperatura elevada. O estado é inseguro e a porta não deve ser aberta com força. Pressionar ▷|| durante 3 seg. para recarregar e colocar na lavandaria. Seguir as instruções abaixo:

1. Aguardar até que o tambor pare de rodar.
2. O fecho da porta está desbloqueado.
3. Feche a porta quando a roupa for recarregada e prima o botão [Inicio/Pausa].



Pressione ▷|| durante 3s.



Inserir as peças de vestuário



Início

# Ficha de produto

Nombre distribuidor<sup>(a),(c)</sup>: EAS ELECTRIC

Dirección<sup>(a),(c)</sup>: P.I. San Carlos, Camino de la Sierra, S/N, Parcela 11 03370 Redován (Alicante) - ESPAÑA

Modelo<sup>(a)</sup>: ADRA100

Parâmetros gerais do produto:

Parâmetros	Valor	Parâmetros	Valor	
Capacidade nominal <sup>(b)</sup> (kg)	10.0	Dimensões em cm <sup>(a),(c)</sup>	Alto	85
			Largura	60
			Fundo	53
Índice de eficiência energética <sup>(b)</sup> (EEL <sub>w</sub> )	51.9	Classe de eficiência energética <sup>(b)</sup>	A <sup>(d)</sup>	
Índice de eficiência de lavagem <sup>(b)</sup>	1.031	Eficiência do enxaguamento (g/kg) <sup>(b)</sup>	5.0	
Consumo de energia em KWh por ciclo para um ciclo de lavagem da máquina de lavar utilizando o programa ECO 40-60 numa combinação de cargas completas e parciais. O consumo real de energia dependerá da forma como o aparelho for utilizado.	0.513	Consumo de água em litros por ciclo para um ciclo de lavagem da máquina de lavar utilizando o programa ECO 40-60 numa combinação de cargas completas e parciais. O consumo real de água dependerá da forma como o aparelho é utilizado e da dureza da água.	52	
Temperatura máxima dentro do tecido tratado <sup>(b)</sup> (°C)	Capacidade nominal	37	Teor de humidade residual ponderada <sup>(b)</sup> (%)	53.9
	Meia	33		
	Quarto	23		
Velocidade de centrifugação <sup>(b)</sup> (rpm)	Capacidade nominal	1350	Classe de eficiência da centrifugação <sup>(b)</sup>	B <sup>(d)</sup>
	Meia	1350		
	Quarto	1350		
Duração do programa <sup>(b)</sup> (h:min)	Capacidade nominal	3:59	Tipo	Independente
	Meia	3:00		
	Quarto	3:00		
Emissões acústicas aero-transportadas durante a fase de centrifugação <sup>(b)</sup> (dB(A) re 1 pW)	72	Classe de emissões acústicas transportadas pelo ar (b) (Fase de centrifugação)	A <sup>(d)</sup>	
Modo desligado (W) se aplicável	0.50	Modo de espera (W) se aplicável	N/A	
Início retardado (W) se aplicável	4.00	Modo espera de rede (W) se aplicável	N/A	

Duração mínima da garantia oferecida pelo fornecedor<sup>(a),(c)</sup>: 3 anos

Este aparelho foi concebido para libertar iões de prata durante o ciclo de lavagem:

NO

Informação adicional:

Web onde pode encontrar as informações do ponto 9 do Anexo II da norma UE 2019/2023<sup>(i)</sup>: [www.ponjohnsonentuvida.es](http://www.ponjohnsonentuvida.es)

<sup>(a)</sup> Estes dados não são considerados relevantes para os fins do artigo 2(6) da UE 2017/1369.

<sup>(b)</sup> Para o programa ECO 40-60.

<sup>(c)</sup> As alterações a estes artigos não devem ser consideradas relevantes para efeitos do n.º 4 do artigo 4.º da UE 2017/1369

<sup>(d)</sup> Se a base de dados gerar automaticamente conteúdo definitivo nesta célula, o fornecedor não deve introduzir estes dados.

Nombre distribuidor<sup>(a),(c)</sup>: EAS ELECTRIC

Dirección<sup>(a),(c)</sup>: P.I. San Carlos, Camino de la Sierra, S/N, Parcela 11 03370 Redován (Alicante) - ESPAÑA

Modelo<sup>(a)</sup>: ADRA120

Parâmetros gerais do produto:

Parâmetros	Valor	Parâmetros	Valor	
Capacidade nominal <sup>(b)</sup> (kg)	12.0	Dimensões em cm <sup>(a),(c)</sup>	Alto	85
			Largura	60
			Fundo	60
Índice de eficiência energética <sup>(a)</sup> (EEL <sub>w</sub> )	52.0	Classe de eficiência energética <sup>(b)</sup>	A <sup>(d)</sup>	
Índice de eficiência de lavagem <sup>(b)</sup>	1.031	Eficiência do enxaguamento (g/kg) <sup>(b)</sup>	5.0	
Consumo de energia em KWh por ciclo para um ciclo de lavagem da máquina de lavar utilizando o programa ECO 40-60 numa combinação de cargas completas e parciais. O consumo real de energia dependerá da forma como o aparelho for utilizado.	0.544	Consumo de água em litros por ciclo para um ciclo de lavagem da máquina de lavar utilizando o programa ECO 40-60 numa combinação de cargas completas e parciais. O consumo real de água dependerá da forma como o aparelho é utilizado e da dureza da água.	57	
Temperatura máxima dentro do tecido tratado <sup>(b)</sup> (°C)	Capacidade nominal	42	Teor de humidade residual ponderada <sup>(b)</sup> (%)	53.9
	Meia	32		
	Quarto	24		
Velocidade de centrifugação <sup>(b)</sup> (rpm)	Capacidade nominal	1350	Classe de eficiência da centrifugação <sup>(b)</sup>	B <sup>(d)</sup>
	Meia	1350		
	Quarto	1350		
Programme duration <sup>(b)</sup> (h:min)	Capacidade nominal	4:00	Tipo	Independente
	Meia	3:00		
	Quarto	3:00		
Emissões acústicas aero-transportadas durante a fase de centrifugação <sup>(b)</sup> (dB(A) re 1 pW)	80.0	Airborne acoustical noise emission class <sup>(b)</sup> (spinning phase)	C <sup>(d)</sup>	
Modo desligado (W) se aplicável	0.50	Modo de espera (W) se aplicável	1.00	
Início diferido (W) se aplicável	4.00	Modo espera de rede (W) se aplicável	N/A	

Duração mínima da garantia oferecida pelo fornecedor<sup>(a),(c)</sup>: 3 anos

Este aparelho foi concebido para libertar iões de prata durante o ciclo de lavagem:

NO

Informação adicional:

Web onde pode encontrar as informações do ponto 9 do Anexo II da norma UE 2019/2023<sup>(1)</sup>: [www.ponjohnsonentuvida.es](http://www.ponjohnsonentuvida.es)

<sup>(a)</sup> Estes dados não são considerados relevantes para os fins do artigo 2(6) da UE 2017/1369.

<sup>(b)</sup> Para o programa ECO 40-60.

<sup>(c)</sup> As alterações a estes artigos não devem ser consideradas relevantes para efeitos do n.º 4 do artigo 4.º da UE 2017/1369

<sup>(d)</sup> Se a base de dados gerar automaticamente conteúdo definitivo nesta célula, o fornecedor não deve introduzir estes dados.

# LIMPEZA E MANUTENÇÃO

## Limpeza e cuidados

### ⚠ ADVERTÊNCIA

- Antes de iniciar a manutenção, desligue a máquina da tomada e desligue a água.

### Limpeza da tampa da máquina

A manutenção adequada da máquina pode prolongar a sua vida útil. A superfície pode ser limpa com detergentes neutros e não abrasivos quando necessário. Se houver qualquer transbordo de água, usar um pano para o limpar imediatamente. Não utilizar objectos afiados nem golpear a máquina de lavar.

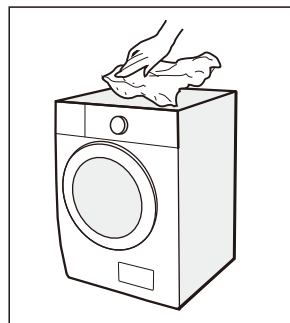

### ⚠ ATENÇÃO

- Não utilizar ácido fórmico ou solventes diluídos ou equivalentes, tais como álcool ou outros produtos químicos.

### Limpeza do tambor

Limpar imediatamente qualquer ferrugem deixada no tambor por objectos metálicos com um detergente sem cloro. Nunca usar esfregões de alumínio para esfregar.

### ● NOTA

- Não colocar roupa suja na máquina durante a limpeza do tambor.

### Limpeza da vedação da porta e do vidro

Limpar o vidro e a junta após cada lavagem para remover o algodão e as manchas. Se o algodão se acumular, pode causar fugas. Retirar moedas, botões ou outros objectos após cada lavagem. Limpar o vidro e a junta uma vez por mês para assegurar o bom funcionamento da unidade.

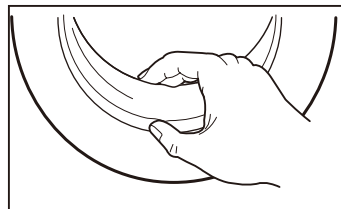

# LIMPEZA E MANUTENÇÃO

## Limpeza do filtro de entrada de água

### ● NOTA

- Se entrar menos água, o filtro de entrada deve ser limpo.

1. Fechar a torneira e retirar a mangueira de entrada.

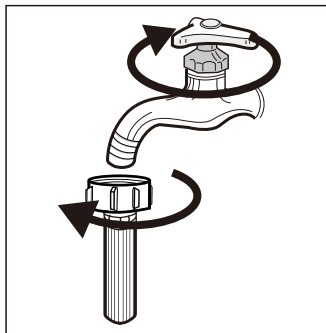

2. Limpar o filtro com uma escova.

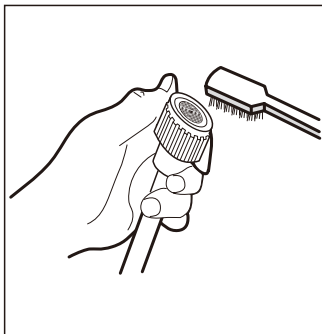

3. Desaparafusar a mangueira de abastecimento de água da parte de trás da máquina de lavar. Retirar o filtro com um alicate comprido.

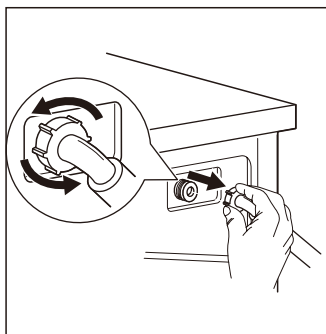

4. Limpar o filtro com uma escova.

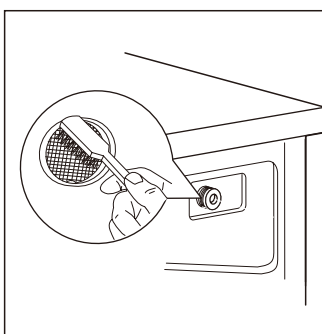

5. Substituir o filtro e a mangueira de abastecimento de água.

6. Limpar o filtro de entrada de 3 em 3 meses para assegurar o funcionamento normal.

# LIMPEZA E MANUTENÇÃO

## Limpeza da gaveta do detergente

1. Pressionar a fechadura  na tampa do amaciador e puxar a caixa do dispensador. Limpar o interior com uma escova.
2. Remover a tampa do amaciador e a caixa do doseador e limpar ambos com água.
3. Substituir a tampa do amaciador e a caixa do dispensador nos seus respectivos recessos.

1. Pressionar a fechadura e puxar a caixa do dispensador.

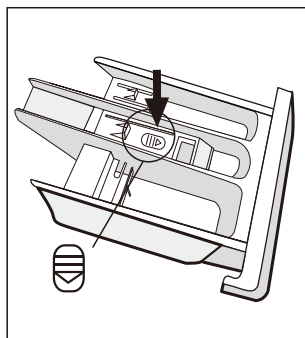

2. Limpar a gaveta do amaciador e a tampa debaixo de água.

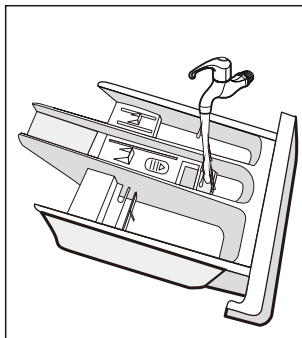

3. Limpar o buraco com uma escova macia.

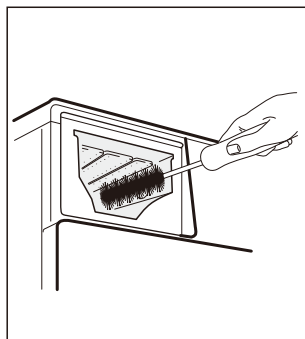

4. Recolocar a caixa

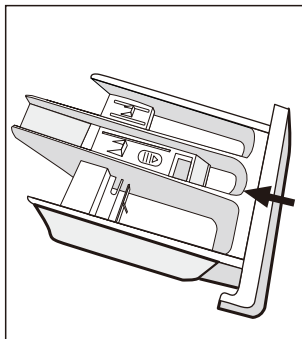

### NOTA

- Não utilizar agentes abrasivos ou cáusticos para limpar plásticos.
- Limpar a gaveta do detergente de 3 em 3 meses para assegurar o funcionamento normal do aparelho.



## Limpeza do filtro da bomba de drenagem

### ⚠ ADVERTÊNCIA

- Certifique-se de que a máquina de lavar e secar terminou o ciclo de lavagem e está vazia. Desligue-a e desligue-a antes de limpar o filtro da bomba de drenagem.
- Ter cuidado com a água quente. Deixe a água arrefecer. Risco de queimaduras.
- Limpar o filtro de 3 em 3 meses para garantir o funcionamento normal.

1. Abrir a tampa inferior

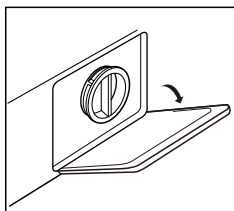

2. Abrir o filtro rodando-o como se mostra na imagem.

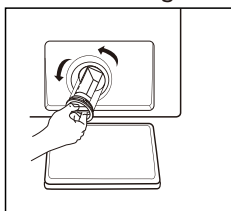

3. Remover quaisquer objectos estranhos

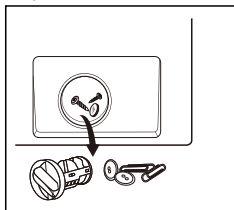

4. Fechar a tampa inferior

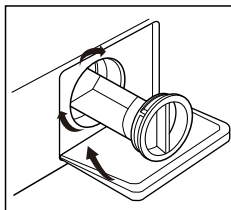

### ⚠ CAUTION

- Quando o aparelho está a ser utilizado e em função do programa seleccionado, pode haver água quente na bomba. Nunca retire a tampa da bomba durante um ciclo de lavagem, espere sempre que o aparelho termine o ciclo e esteja vazio. Quando voltar a colocar a tampa, certifique-se de que está bem apertada.

# RESOLUÇÃO DE PROBLEMAS



Se a máquina não funcionar, consulte esta tabela para encontrar uma solução para o problema. Se isto não resolver o problema, contacte o seu representante de serviço.

Descrição	Motivo	Solução
O aparelho não arranca	A porta não está devidamente fechada. A roupa está encravada.	Fechar a porta e verificar se a roupa não está encravada.
A porta não se pode abrir	Safety protection is activated.	Desligar a máquina de lavar e reiniciar o aparelho.
Fuga de água	Connections are not tight enough.	Verificar e apertar os tubos de água. Limpar o tubo de drenagem.
Vestígios de detergente no distribuidor	O detergente molha-se ou junta-se em tufo	Limpar e secar a caixa de detergente.
O indicador ou o ecrã não se acende	A placa não tem potência ou o arnês tem um problema de ligação.	Verificar se a corrente está desligada e se a ficha está bem ligada.
Ruído anormal	Os parafusos de transporte ainda estão no lugar. O chão não é sólido ou plano.	Verificar se os parafusos de fixação foram removidos. Verificar se a máquina está instalada sobre um pavimento sólido e nivelado.

## Códigos de erro

Descrição	Motivo	Solução
<b>E30</b>	A porta não fechou devidamente	Fechar a porta com segurança e reiniciar.
<b>E10</b>	Problema de entrada de água durante a lavagem	Verificar a pressão da água. Endireitar o cano de água. Filtro de válvula de entrada limpo.
<b>E21</b>	Excesso de tempo na drenagem	Verificar se o dreno está bloqueado
<b>E12</b>	Transbordamento de água	Reiniciar a máquina de lavar
<b>EXX</b>	Outros	Reiniciar a máquina de lavar, ou chamar para serviço.

# ELIMINAÇÃO E RECICLAGEM

  <p><b>DISPOSIÇÃO:</b> Não eliminar este produto como lixo municipal não separado. É necessário recolher estes resíduos separadamente para tratamento especial.</p>	<p>De acordo com a directiva europeia 2012/19/UE relativa aos resíduos de equipamentos eléctricos e electrónicos (REEE), os aparelhos domésticos não podem ser eliminados nos contentores municipais habituais; devem ser recolhidos separadamente a fim de otimizar a recuperação e reciclagem dos seus componentes e materiais e de reduzir o impacto na saúde humana e no ambiente.</p> <p>O símbolo do caixote do lixo com uma cruz é marcado em todos os produtos para lembrar ao consumidor a obrigação de os separar para recolha separada. O consumidor deve contactar a autoridade local ou o retalhista para obter informações sobre a correta eliminação do seu aparelho eléctrico.</p>
---	--

## Serviço pós-venda

As peças sobresselentes para o seu aparelho estão disponíveis durante um período mínimo de 10 anos, de acordo com os requisitos de concepção ecológica do ANEXO II do REGULAMENTO (UE) 2019/2023 da Comissão Europeia.

Em caso de dúvidas, contacte o nosso centro de atendimento ao cliente local.

### ADVERTÊNCIA

Risco de choque eléctrico:

- Nunca tente reparar um aparelho defeituoso sozinho. Pode pôr em perigo a si próprio e a outras pessoas que o utilizem. As reparações só podem ser efectuadas por especialistas autorizados.
- As reparações incorrectas anularão a garantia e qualquer dano resultante não será reconhecido.

## Transporte

### PASSOS IMPORTANTES PARA A DESLOCAÇÃO DO APARELHO

- Desligar o aparelho da tomada e fechar a entrada de água.
- Verificar se a porta e a caixa do dispensador estão devidamente fechadas. Remover a mangueira de entrada e drenagem da instalação doméstica. Deixar a água escoar completamente para fora do aparelho (ver "Limpeza do filtro da bomba de drenagem").
- Importante: Reinstalar os 4 parafusos de transporte na parte de trás do aparelho.
- O aparelho é pesado, transportá-lo com cuidado. Nunca o segurar por nenhuma das suas partes salientes e não usar a porta como maçaneta.

## CONDIÇÕES DA GARANTIA

Este aparelho é garantido por três anos a partir da data de venda contra todos os defeitos de fabrico, incluindo mão-de-obra e peças sobressalentes. A fim de justificar a data de compra, será obrigatório apresentar a factura ou o recibo de compra. As condições desta garantia aplicam-se apenas a Espanha e Portugal. Se tiver adquirido este produto noutro país, consulte o seu distribuidor para as condições aplicáveis.

### EXCLUSÕES DA GARANTIA

1. Controles remotos, borrachas de entrada de drenagem, encaixes e vedações de portas, proteção contra calafetação
2. Danos em esmaltes, tintas, niquelagem, cromagem, oxidação ou outros tipos de peças ou componentes estéticos que não afetam o funcionamento interno do aparelho.
3. Danos nas peças de desgaste devido ao uso, corrosão ou oxidação, sejam causados pelo uso normal do aparelho ou deterioração acelerada devido a circunstâncias ambientais ou climáticas desfavoráveis. Não é adequado para uso ao ar livre.
4. Danos em peças frágeis de vidro, vitrocerâmica, plásticos, puxadores, cestos, portas ou lâmpadas, quando a sua falha ou quebra não seja atribuível a defeito de fabricação.
5. Avarias causadas por causas fortuitas ou acidentadas de força maior, ou como consequência de uso anormal, negligente ou impróprio do dispositivo.
6. Responsabilidade civil de qualquer natureza.
7. Danos consequentes no aparelho, desde que não sejam causados por uma avaria interna.
8. Manutenção ou conservação do aparelho: revisões periódicas, ajustes e graxas.
9. Defeitos que possam sofrer acessórios e complementos, adaptadores, cabos externos, bolsas, peças de reposição de todos os tipos, lâmpadas, bem como qualquer peça considerada consumível pelo fabricante.
10. Falhas causadas por instalação incorreta ou ilegal, ventilação inadequada, falta de aterramento em casa, falhas de energia, modificações inadequadas ou uso de peças sobressalentes não originais.
11. Aparelhos usados em aplicações industriais ou para fins comerciais.
12. Aparelhos com número de série ilegível ou alterado.
13. Defeitos ou avarias produzidos como resultado de reparos, modificações ou desmontagem da instalação do dispositivo pelo usuário ou por um técnico não autorizado pelo fabricante, ou como resultado do não cumprimento manifesto das instruções do fabricante para uso e manutenção.
14. Durante o período de garantia é imprescindível manter todos os manuais junto com o equipamento. Se o equipamento for vendido, ou doado, o manual e todos os documentos relacionados devem ser entregues ao novo usuário. Se algum deles for perdido, sua substituição não poderá ser reivindicada.
15. Falhas que tenham origem ou sejam consequência direta ou indireta de: contato com líquidos, produtos químicos e outras substâncias, bem como condições derivadas do clima ou do meio ambiente: terremotos, incêndios, inundações, calor excessivo ou qualquer outra força externa, como insetos, roedores e outros animais que possam ter acesso ao interior da máquina ou seus pontos de conexão.
16. Danos derivados de terrorismo, motim ou tumulto popular, manifestações e greves legais ou ilegais; fatos das ações das Forças Armadas ou das Forças de Segurança do Estado em tempos de paz; conflitos armados e atos de guerra (declarados ou não); reação nuclear ou radiação ou contaminação radioativa; vício ou defeito das mercadorias; factos classificados pelo Governo da Nação como "catástrofe ou calamidade nacional".

**O design e as especificações estão sujeitos a alterações sem aviso prévio para melhoramento do produto. Quaisquer alterações ao manual serão actualizadas no nosso sítio web, pode consultar a versão mais recente.**



Escanee para ver este manual en otros idiomas y actualizaciones  
Scan for manual in other languages and further updates  
Manuel dans d'autres langues et mis à jour  
Manual em outras línguas e atualizações

**johnson**

Polígono Industrial San Carlos,  
Camino de la Sierra S/N Parcela 11  
03370 - Redován (Alicante)

[www.ponjohnsonentuvida.es](http://www.ponjohnsonentuvida.es)

Toda la documentación del producto  
*Complete documents about the product*  
*Documentation plus complète sur le produit*  
*Mais documentação do produto*

